

CEO's Voice

Ncell: Accelerating Digitalisation
Post-Pandemic

Expert View

Building Precision
5G Transport Network
for Innovation in
Various Industries

Special Topic:

Precision 5G

Transport Network





ZTE TECHNOLOGIES

APR 2021 | VOL. 23 • NO. 2 • ISSUE 193

Advisory Committee

Director: Liu Jian

Deputy Directors: Sun Fangping, Yu Yifang,
Zhang Wanchun, Zhu Yongxing

Advisers: Bai Gang, Chen Jian,
Chen Xinyu, Fang Hui, Heng Yunjun,
Tu Yaofeng, Hong Gongcun, Wang Qiang

Editorial Board

Director: Lin Xiaodong

Deputy Director: Huang Xinming

Members: Chen Zongcong, Gao Hong, Hu Junjie,
Huang Xinming, Jiang Wen, Liu Qun, Lin Xiaodong,
Shen Lin, Shen Shanhong, Wang Quan, Yang Zhaojiang

Sponsor: ZTE Corporation

Edited By Shenzhen Editorial Office

General Editor: Lin Xiaodong

Deputy General Editor: Huang Xinming

Editor-in-Chief: Liu Yang

Executive Editor-in-Chief: Yue Lihua

Circulation Manager: Wang Pingping

Editorial Office

Address: NO. 55, Hi-tech Road South, Shenzhen, P.R.China

Postcode: 518075

Tel: +86-755-26775211

Fax: +86-755-26775217

Website: www.zte.com.cn/en/about/publications

Email: yue.lihua@zte.com.cn

Statement: This magazine is a free publication for you. If you do not want to receive it in the future, you can send the "TD unsubscribe" mail to magazine@zte.com.cn. We will not send you this magazine again after receiving your email. Thank you for your support.

CONTENTS

CEO's Voice

02 Ncell: Accelerating Digitalisation Post-Pandemic

Reporter: Luo Jinfeng

Expert View

06 Building Precision 5G Transport Network for Innovation in Various Industries

By Wang Qiang

Special Topic: Precision 5G Transport Network

10 Technology Evolution for Precision 5G Transport Network

By Zhao Fuchuan, Zhang Baoya

14 Precise and Flexible Slicing for Transport Networks

By Cui Yanyun, Song Bing

18 Constructing a New-Generation 5G Transport Network Based on SRv6

By Zhang Baoya

22 Enabling Cloud-Network Synergy with Precision 5G Transport Network

By Ma Yuxia



26 Research into the Deployment and Application of Intelligent Time Network

By He Li

30 Intelligent OAM of 5G Network

By Xiao Hongyun

Success Stories

34 ZTE Helps China Unicom Shenzhen Verify the World's First 5G SA E2E Slice

By Zhou Wenduan, Guo Qianlin

36 China Telecom Partners with ZTE to Build a New Metropolitan Area Network

By Liu Bingnan

39 True Teams up with ZTE to Build a Superior 5G IPRAN Network

By Liao Wang



Ncell: Accelerating Digitalisation Post-Pandemic

Reporter: Luo Jinfeng



Andy Chong Yee Bin, Chief Executive Officer/Managing Director of Ncell, talks about the telco's presence in Nepal, performance during the pandemic, and how it copes with the new normal after the COVID-19 pandemic. Andy has held CEO and top management positions in Malaysia, Singapore and Indonesia, where he led teams to build and grow businesses and in providing strategic direction in the areas of sales & marketing, technical & operations and finance.

As the leading mobile operator in Nepal, could you please give us an overview of Ncell's achievements in Nepal during the past few years?

Ncell has been operating in Nepal since 2004 as the first private mobile operator in the country. We provide high quality international standard services with a local touch. Over 98% of our employees are Nepali and our services are designed to meet the needs of the people of Nepal.

At Ncell, we are constantly working towards our goal of connecting everyone in Nepal through our nationwide network, providing high quality, modern and cost-effective services for the consumers, and creating value for our partners.

Ncell became a part of Axiata Group Berhad post completion of acquisition on 11 April 2016. Together with Axiata, Ncell is committed to contribute to the development of the country's economy and infrastructure, building best-in-class networks and bringing people in the remotest areas of Nepal within the reach of communications.

As one of the biggest foreign investors in Nepal, we take pride for being one of the highest tax payers of the country—from the time of its inception till date, Ncell has paid over Rs 242 billion in income taxes and fees to the government, with Rs 32.22 billion just in the last fiscal year 2019/20, accounting for 3.8% of the total tax revenue of the government.

Our direct and indirect contribution to the country's GDP stood at 2 percent in 2018/19. As a committed investor in Nepal, we have made a substantial investment in infrastructure for service expansion and enhancing quality. We invest between Rs 32–35 billion annually in Capex and Opex which directly or indirectly supports and drives growth in the economy. Infrastructure investments especially telecommunications have strong links to growth, poverty

alleviation and environmental sustainability.

Through our investments, we have introduced new technological solutions that has resulted in positive externalities to include direct economic benefits via employment, affordable means of communications resulting in social and economic benefits for our customers, better provision of social services like education and health, decentralisation and integration processes, human welfare and overall economic development.

We have directly and indirectly, created employment opportunities for approximately 57,000 people. Increased investment from company like Ncell will contribute to expand the overall infrastructural base of the country and further support the Nation's 'Digital Nepal' initiatives.

During the pandemic, economic activity has come to a standstill globally, while the telecommunication business appears to be least affected. How is the situation of Ncell? Has there been a slowdown in Ncell's growth in terms of customers as well as profit?

It is true telecommunications businesses have been more resilient than many other industries which have been impaired by as much as 95% for example, the tourism and hospitality industries. For Ncell, while we are in a relatively better position compared to other big businesses, the telecoms was not spared. During the pandemic situation, access to communications, content, services, entertainment were almost uniquely channeled via data connectivity and data consumption has been heightened. In Nepal, telecommunications network utilisation has increased by more than 40%. However, the impact of increased use of telecom services with people living at home and working from home have not translated to higher revenues for mobile operators as people, being at home, were using fixed broadband alternative.

In the past year, there were two waves of stringent lockdowns in Nepal—which impaired movement of people for almost half of 2020. During this time, mobile telecom companies were compelled to provide its essential services at highly discounted and subsidised rate to ensure our customers had connectivity during lockdowns. For example, we provided 120% bonus on top up, increased Saapati (micro-credit) amount, made balance transfer services available for free, free mobile services to over 160,000 front liners and provided 25% discount in PAYG data, among others.

During the lockdown, despite data traffic increasing by as much as 40%, overall revenues declined by as much as 35% during its peak. With easing of lockdown towards end 2020, our business has since recovered to 28% of pre-lockdown levels. Yet, this will take some time to reach to pre-Covid levels—we often refer to as 'normalcy', or some semblance of it.

It is evident that consumer consumption behaviour has changed during this period as well—we see a shift from voice usage to data (mostly fixed broadband data) during the lockdown. Notwithstanding this shift, we continued to invest in our data carrying capacity throughout 2020.

As many as 1 million Ncell customers stopped using their services during the lockdown which, we assume, is due to businesses getting impacted resulting in loss of employment for many people. It was estimated no more than 3% of our Points of Sales (PoS) were opened during the lockdown which affected our business and when the government eased lockdown, we saw around 25% of PoS were re-opened. This has a direct impact to the recharge activities of consumers.

I am hopeful businesses including ours, will begin its recovery journey towards pre-Covid normalcy in 2021, and perhaps even longer for some industries like tourism

and hospitality. The impact has dug deep into the structure of Nepal's economy and will need a longer runway to recover, which at least for our industry, will follow a moderate L-shape. It will be an excellent outcome if businesses recover to within 90% of pre-Covid levels by end 2021.

Nowadays, operators are seeking digital transformation. How does Ncell implement digital transformation? How do you see the help it brings for Ncell during and after pandemic?

Digital transformation has been on our agenda right at the on-set but it wasn't until the pandemic hit us which necessitate, we accelerate our digital transformation. We learnt (the hard way) during the pandemic that engaging with our customers digitally would have resulted in a more resilient 2020 for Ncell. We initiated and fast tracked several major digital initiatives around digitalising our customer and channel engagement value chain amongst others—where customers will engage with us digitally, and not physically which has been a challenge during pandemic times. These were rolled out beginning December 2020 and we continue to drive adoption and over-time, utilisation and monetisation as the new engagement model with our consumers. This will no doubt require consumers to embrace and become comfortable with this new mode of engagement, but we are confident this will become second nature. It is evident from many other markets/operators, where a digitalised engagement value chain had resulted in a more robust and resilient 2020 for mobile consumers and the operators.

Regarding the network development, what is your investment plan for the existing 4G network and any plan for 5G network in Nepal?

Our plans to roll out our 4G nationwide is

ready and is a function of availability of the right spectrum. We will require multiple frequencies—both for capacity enhancement and for expansion of coverage. We launched 4G in June 2017 and expanded it to all provinces of Nepal.

Spectrum at 900 MHz is required to deliver population coverage. We have 58% 4G population coverage and as soon as we are awarded technology neutral spectrum in this band, we will be able to expand 4G coverage to over 90% of population coverage, so we will continue to invest in expanding our network. We are hopeful this will be resolved soon so we can better serve consumers with 4G services.

With spectrum in 1800 MHz band that we secured in December 2019, we will give depth of 4G coverage to deliver higher data speeds and capacity within the coverage area. But to serve wider geography, we need technology neutral spectrum in 900 MHz.

And, for 5G, we would welcome Nepal Telecommunications Authority's leadership in setting up industry consultations to ensure timely availability. From our point of view this will likely be post implementation of our nationwide 4G plans.

What do you think of ZTE's contribution to your network development? And what do you expect from the future cooperation with ZTE?

As a trusted partner of Ncell, ZTE has cooperated with Ncell for over 10 years to provide wireless, core network and transport network services in Nepal, meeting more than 60% of Ncell's wireless network business needs. We are grateful to ZTE for their presence and support. Moving forward, ZTE and Ncell will continue to strengthen the collaboration to enable Ncell to attain network and digital transformation through ZTE's industry-leading solutions and technologies, contributing to the further development of Nepal's telecommunications industry.

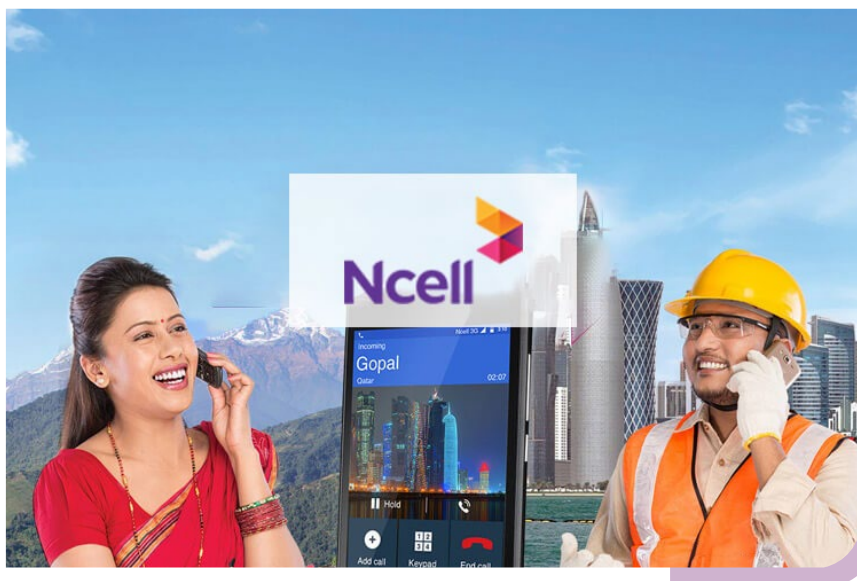

What are your prospects for Ncell in the next few years and what are your priorities?

We are giving priority to digitalisation of our key business activities where meaningful and impactful so that post pandemic, we can be ahead of the curve and better able to serve our customers.

Our business strategy and investments will remain focused on data oriented services, which is where the growth will be. Nepal has the opportunity to pull forward with their Digital Nepal 2020 programme—both from a supply and demand perspective. Had Nepal been up the curve in terms of its digital economy, the impact, for businesses such as ours, would have been lessened with easier and simpler access to services for customers.

Data is the future and there is significant opportunity for growth as Nepal embraces a digital future. Share of data revenues of mobile telecom companies have been increasing year on year whilst demand for voice services remains relatively constant. We aspire to be a digital telco and our strategy is data-centric. And for enterprises, we hope to be first choice of Nepali businesses to help them achieve their aspirations in the near future. **ZTE TECHNOLOGIES**

Building Precision 5G Transport Network for Innovation in Various Industries

Wang Qiang, Deputy General Manager of ZTE BN Products

Services drive network development. In order to meet the need of differentiated services in the 5G era, three major operators in China all conducted centralized procurement of 5G transport networks and started large-scale construction in the first half of 2020. More than 200,000 5G transport devices have been deployed in China, and China has built the world's largest 5G transport network. With the advancement of new infrastructure, 5G will inevitably drive operators to extend from ToC to ToB. To bring 5G into full play in various vertical industries, it is necessary to have a deeper understanding of 5G features and service requirements, and to continually make technological innovation.

Shift from ToC to ToB

Although 5G transport network aims at ToC at the first stage, 5G features make it destined to go beyond traditional human-to-human communication. GSMA predicts that 5G will generate \$619 billion in revenue for operators in the ToB sector by 2026, accounting for 36% of total revenue. Among them, transportation and autonomous driving will bring \$120 billion, accounting for 19%, while smart manufacturing \$113 billion, 18% (Fig. 1). The integrated applications of 5G and vertical industries will become the key to future development.

In the R15 that was frozen in 2018, 3GPP studied and set standards for the enhanced mobile broadband (eMBB) scenario, made clear the forward-compatibility ultra reliable low

latency communication (URLLC) and massive machine type communication (mMTC) scenarios, and worked out key network indicators in the vehicle-to-everything (V2X) and industrial control scenarios. The 5G performance defined by ITU contains a connection density of $10^6/\text{km}^2$, an air interface delay of 1 ms and a mobile speed of 500 km/h, which can be a good support to low-latency scenarios such as industrial & transportation automation and automatic driving, as well as to massive connection scenarios such as massive sensors and smart homes.

2020 witnessed the accelerated new infrastructure deployment and rapid 5G development. As the driver of new infrastructure, 5G is bound to shift operators from ToC to ToB and promote full integration with other technologies. Operators have coordinated efforts from

The precision 5G transport network needs a complete coordination of clouds, networks, edges and terminals to create greater value for enterprise users, and also needs to strengthen the coordination with RAN and core network.

Wang Qiang



multiple departments to constantly broaden and deepen 5G industry applications. Key research projects cover the fields of medical care and epidemic prevention, industrial internet, media and entertainment, and internet of vehicles, and a number of mature cases have emerged. It can be predicted that 5G applications in vertical industries will give rise to more emerging needs and services, and will continue to expand new areas for digital economy.

The R16 standard was frozen in July 2020, of which URLLC scenarios and features are the most important part. R16 enhances industry applications and defines the scenarios and technologies related to transport networks.

- R16 strengthens technical expansion and applications of time sensitive network (TSN), supports the integration of TSN and 5G, and can use 5G NR to replace the wireline network in the campus, making industrial production more flexible.
- In terms of traffic control, R16 uses the diameter overload indication conveyance (DOIC) mechanism similar to the Diameter protocol, carries traffic control information in HTTP messages, achieves active flow control between network elements, and reduces the risk of network congestion when sudden traffic occurs during peak hours.

- In terms of slicing, R16 connects the operator network and the enterprise-side authentication system, and allows enterprises to flexibly control the access through a secondary slice authentication. It can also select target AMF and V/I-SMF according to NSSAI during the handover from 4G to 5G to enable slice interoperability.
- R16 starts research into 5G-based V2X. Through 5G lower latency, higher reliability and larger capacity, R16 builds a communication network between vehicles and vehicles, vehicles and people, and vehicles and roadside infrastructure to enable information exchange.

Driven by network readiness, policy guidance and standards freezing, industry applications have developed from their infancy.

Technological Innovation to Meet Industry Needs

Traditional ToC businesses focus on bandwidth, while ToB businesses focus on end-to-end service experience such as latency, jitter, security and isolation. Different vertical industries or application scenarios have different

requirements for network bandwidth, delay and other KPIs. Big videos need large bandwidth, low latency, as well as cloud-based content processing such as image splicing and encoding/decoding in MEC to reduce terminal weight, costs, network load and O&M pressure, and lower requirement for energy consumption and performance. Services like remote control and autonomous driving need low latency and high reliability. Smart grid needs low-cost, flexible, efficient, secure and reliable RAN transport as well as more automatic and controllable network management.

In the pre-research stage of 5G transport networks, industry applications have been brought into the key research to meet differentiated SLA requirements of vertical industries. The key technologies include SR, inband OAM, telemetry, FlexE, high-precision time synchronization, as well as centralized management and orchestration. With the expansion of 5G applications, transport technologies are evolving and improving.

To leverage the commercial value of 5G, telecom operators need to create new business models and new capabilities, which put forward new technical requirements. China Mobile has

proposed a new service-oriented network model that contains preferential, exclusive and premium services. To match high-value users in the power and finance sectors, the slice granularity has been refined from 5 Gbps to 10 Mbps, which has led to technological innovation in small granules and hard-isolated slices, and accelerated the work of related technical specifications and verification. To facilitate enterprises to access the cloud, China Telecom and China Unicom have actively introduced SRv6 to bridge the gap between CT and IT. The operators have also actively introduced slicing and SD-WAN technologies to quickly offer different SLA services to enterprise users in different scenarios with the help of end-to-end service management and orchestration system.

With a deep insight into the challenges faced by operators in expanding the ToB market, ZTE has put forward the concept of precision 5G transport network. The concept integrates innovative technologies such as precise pipelines, precise management and control, precise diagnosis, and precise time, which can provide users with 10 Mbps hard slicing and lossless bandwidth adjustment, minute-level automatic slicing, millisecond-

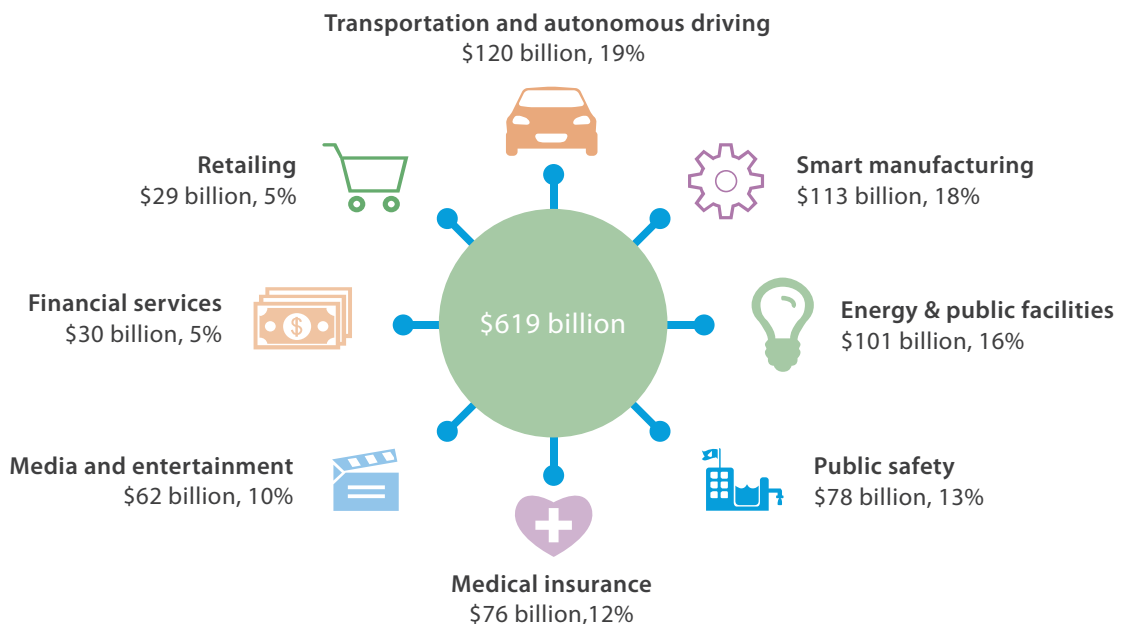
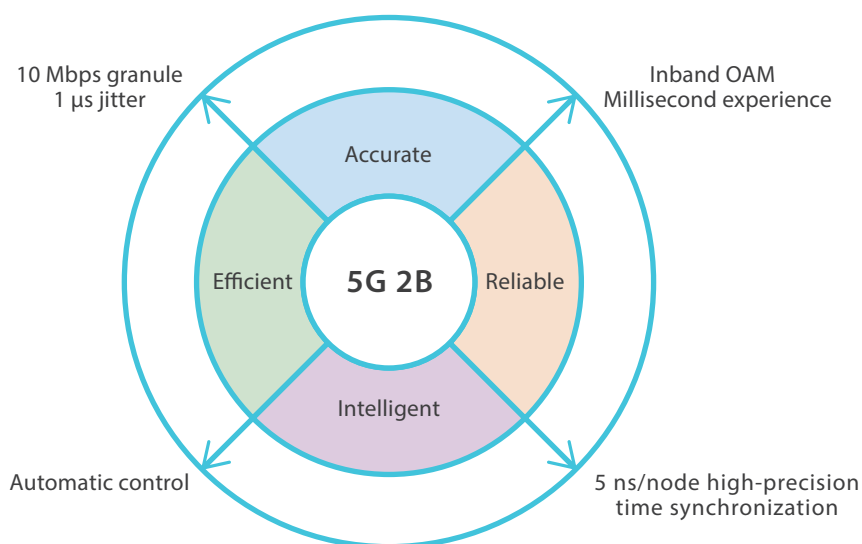

Fig. 1. Revenue expectation in the ToB sector.



◀ Fig. 2. ZTE's precision 5G transport network.

level service monitoring, and 5 ns single-node intelligent clock (Fig. 2).

The precision 5G transport network delivers precise pipelines on the forwarding plane to achieve deterministic forwarding, supports one-hop service transmission and physical-level security isolation, and provides infrastructure for on-demand slicing. It provides precise control on the management and control plane to match network resources with SLA services on demand, delivers exclusive resources and functions to industry users, and distributes slices automatically. After services are carried on demand, it implements precise diagnosis to offer immersive service experience and optimizes the network in real time to enable the closed-loop lifecycle service management. It provides precise time for ultra-high-precision synchronization and coordinates synchronization in smart factories while satisfying deterministic forwarding. It also differentiates protection services for power grid and supports indoor positioning based on synchronization.

The precision 5G transport network needs a complete coordination of clouds, networks, edges and terminals to create greater value for enterprise users, and also needs to strengthen the coordination with RAN and core network. This is exactly the advantages of ZTE as the world's leading provider of end-to-end products and solutions. ZTE continues to build and evolve

end-to-end network capabilities based on the concept of automation, intelligence, complete convergence, and full-service. It uses the slicing technology to implement global resource scheduling, network-based resource orchestration, and end-to-end SLA guarantee, providing users with an end-to-end precision network. The precision network will help operators deploy 5G quickly, cope with the long-term development of vertical industries, and surpass rivals in the 5G loE era.

Conclusion

With the deepening of industry needs and technical growth in future, the precision 5G transport network will have new connotations such as more accurate understanding of service requirements, accurate user experience and network coordination status, accurate network intent execution, and accurate QoS guarantee. These will be foreseeable development trends of the precise 5G transport network, and will ultimately lead to precise resource scheduling and O&M, precise network customization for extremely rich scenarios, and effective Opex reduction. The industry applications will surely be colorful in the upcoming years, and the ever-evolving precision 5G transport network will help operators embrace new services and create new value. **ZTE TECHNOLOGIES**

Technology Evolution for Precision 5G Transport Network



Zhao Fuchuan

Chief Engineer of ZTE 5G Transport Planning



Zhang Baoya

Chief Engineer of ZTE 5G IPRAN Planning

5 G is important for IoT, and supports two major applications: ToC mobile broadband applications for individuals and ToB applications for vertical industries. Vertical applications are becoming the focus of the 5G industry chain as they are key to revenue growth for operators and digital upgrade of various industries. Vertical applications also put new requirements on 5G transport networks and challenge the traditional packet transport technologies.

Challenges Facing Traditional Packet Transport Technology

Vertical applications provide services through 5G network slices. ToB slicing services differ greatly from ToC services in terms of the SLA requirements. Based on requirements for slicing resources and value-added functions, the industry proposes a hierarchical service model including premium, exclusive, and preferential services. The premium service requires that the network should provide exclusive physical forwarding bandwidth and high-reliability performance with zero packet loss, low jitter, and deterministic latency. The

exclusive service requires dedicated LSPs to support forwarding with high quality service bandwidth and latency guarantee. The preferential service requires shared LSPs to guarantee high-priority services based on QoS. Among them, the premium service is designed to meet the requirements of the URLLC scenarios in the ToB industry. These include industrial Internet, power differential protection and VIP government & enterprise service that require guaranteed bandwidth and also high network reliability (zero packet loss) and low deterministic latency.

In terms of network resources, ToB services put stricter requirements on resource guarantee and security isolation. Dedicated network resources are required to guarantee the high security of important production services. Some vertical industry applications, such as wide area monitoring, control and protection for power grids and base station positioning services, require 5G networks to provide highly accurate



time synchronization. Moreover, vertical applications drive the downward shift of MEC services to realize service localization, and the requirements of service function chaining (SFC) drive the cloud-network synergy. The service traffic and flow directions are getting more complicated, which put higher requirements on end-to-end slice programmability and intelligent service provisioning. The service-level real-time monitoring of network performance becomes essential to 5G slice OAM.

These 5G ToB requirements pose great challenges to the traditional IP/MPLS packet transport technology. The traditional packet forwarding technology is based on the best-effort forwarding mechanism. Although it can provide QoS priority-based scheduling, queue congestion due to service bursts during the scheduling makes it difficult to precisely control the network latency. There are also service resource isolation problems. The caches and queues are shared by multiple flows so that the forwarding resources of ToB slicing services cannot be exclusively occupied.

Precision 5G Transport Solution for Industry Applications

The precision 5G transport solution addresses the above-mentioned challenges and can fundamentally solve vertical service transport problem. Its architecture is shown in Fig. 1.

The forwarding plane of the precision transport network is capable of carrying physical resources slices for nodes and links. The key technologies are FlexE and RFC7625 (IP hardened pipes) small granularity slicing. The physical layer slicing technology can not only implement link resource slicing but also end-to-end network resource slicing, to realize deterministic end-to-end latency. The forwarding layer supports MPLS-SR/SRv6 technology to provide network programming capabilities with source routing for VPN services. It supports routing between the base station and the UPF through the PCEP slicing service, and provides ubiquitous connectivity for VPN services through SR-BE.

The management and control plane integrates the network slice subnet management function (NSSMF). It is interconnected with the upper-layer NSMF to support the full lifecycle management of the slice. This plane collects the topology information from the forwarding plane in real time through the BGP-LS plane, creates the VPN through Netconf, and delivers the orchestrated VPN service path to the forwarding plane through the PCEP interface to create the service connection for slices. It collects the slice alarms and real-time performance information (including bandwidth, packet loss and latency) from the forwarding plane via Netconf and Telemetry interfaces.

The key technological directions of the precision 5G transport network include deterministic small-granularity hard slicing, SRv6 cloud-network programmability, high-precision intelligent time synchronization and intelligent end-to-end slice OAM system.

Small Granularity Slicing

For latency-sensitive vertical services, the transport network needs to introduce the “zero packet loss” network with controllable end-to-end latency and guarantee the isolation of forwarding resources for latency-sensitive services. The FlexE-based small-granularity technology is

developed to meet this requirement. It introduces IP hardened pipes to allow small-granularity services to use dedicated bandwidth, and provides the extended Slice+ protocol (draft-ietf-isis-segment-routing-extensions) to create the end-to-end hardened LSP service paths that allow the physical layer isolation of channels. The channel with the minimum granularity of 1 Mbps can flexibly provide the Nx1M bandwidth that matches the granularities of latency-sensitive services. Each small-granularity channel has the corresponding physical time slot, and can implement resource guarantee and strict physical isolation in any scenario. The small-granularity channels can support current L2/L3 VPN services.

SRv6

Targeting the programmable service chain applications brought by a downward shift of 5G MEC, such as cloud POP node transport requirements, SRv6 is considered a technology for cloud-network synergy. SRv6 uses a 128-bit network instruction to define network functions. Each instruction consists of three parts: network node ID, operation code and required parameters. Through the instruction stack, it can control the forwarding and service processing behaviors of network equipment. In this way, it enables service programming in the cloud-network synergy

Fig. 1. Precision 5G transport network architecture.

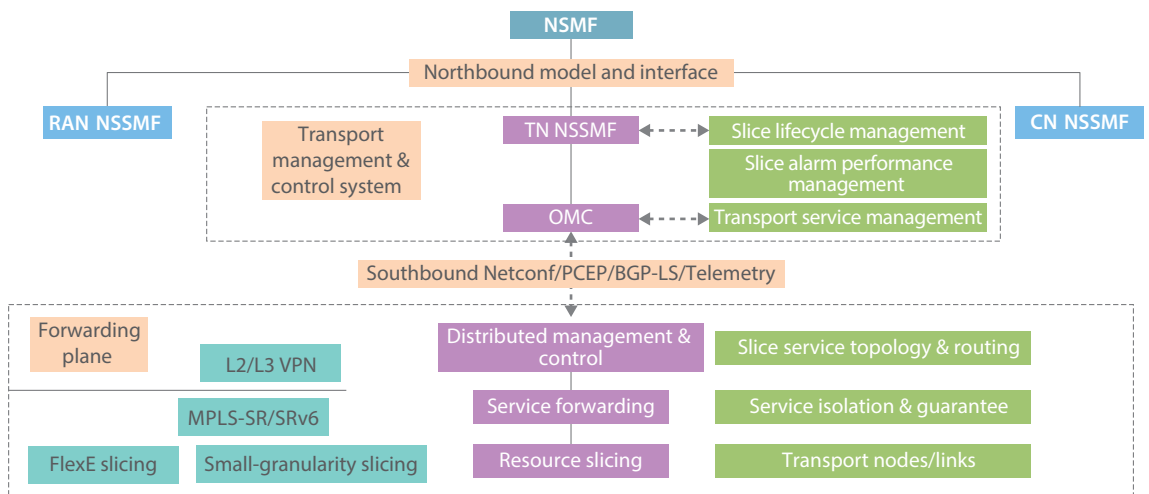

scenario and implements unified orchestration of SFCs based on cloud service and transport network forwarding paths. SRv6 greatly simplifies the network protocols in the cloud-network synergy scenario and provides seamless network orchestration capability.

High-Precision Intelligent Time Synchronization

Some applications in the vertical industry require the 5G network to provide high-precision time service. The latest 3GPP R16 standard also specifies the indicators for high-precision time service of the 5G network. The traditional ground time synchronization system of a 1588v2 transport network cannot meet the time synchronization precision and OAM requirements of large-scale networking scenarios. By introducing such technologies as equipment-level high-precision timestamp, single-fiber bidirectional optical module, base station time difference backhaul, time network domain division and AI-based intelligent time network management and control, the high-precision intelligent time synchronization technology solves the pain points of the traditional 1588v2 approach in large-scale network scenarios by improving the time synchronization precision of a single node to 5 ns from 100 ns. It can rapidly locate and isolate the faults in the time network, fully meeting the OAM requirements of 5G ToB applications for high-precision time synchronization in large-scale networking scenarios.

Intelligent E2E Slice OAM

The number of connections and flow directions of 5G end-to-end slice services are very complicated. For more efficient slice service provisioning and precise delivery, the intelligent E2E slice OAM is very important. After the slice service provisioning is initiated from an app, the communication service management function (CSMF) will perform user authentication, and the NSMF will perform slice orchestration across the radio access network, the transport network and the core network. The

transport network needs to support identification of the slice service, and provide the slice topology resource mapping and service orchestration capability according to the access information of the slice endpoints and the SLA requirements delivered by the NSMF.

Intelligent OAM shortens the slice service provisioning time from days to minutes while ensuring precise service delivery. This fundamentally solves service misconnections caused by human errors and ensures the security of slice services. After the service is provisioned, the transport network can provide in-band OAM based on the service layer. In-band OAM detects the packet loss, latency and jitter on a per-flow basis and provides online SLA monitoring of the slice service. When a fault or congestion occurs, it can restore the real-time forwarding path of the slice service and provide hop-by-hop localization of faults, packet loss and threshold-crossing latency, thus realizing intelligent provisioning, visualization and OAM capabilities of slices services.

Summary

The 5G ToB vertical industry applications drive the technology evolution for the precision 5G transport network. Evolution directions mentioned above enable the intelligent and precise delivery of ToB vertical slice services in the transport network, precise end-to-end SLA performance guarantee and precise service perception, solving the pain points in combining 5G communication networks with vertical industries. At present, the precision 5G transport technology has been piloted on operator networks. Differentiated services such as premium, exclusive and preferential services can be provided on one physical transport network according to the vertical slicing requirements. This greatly improves the resource utilization and service provisioning capability of the 5G transport network, and helps realize the goal of empowering thousands of industries with 5G. [ZTE TECHNOLOGIES](#)

Precise and Flexible Slicing for Transport Networks



Cui Yanyun

Planning Director of ZTE
BN Products



Song Bing

Planning Director of ZTE
BN Products

To meet diverse, differentiated and strict quality requirements of 5G vertical industry applications, 5G transport network architecture needs to be more flexible and adaptable to services.

5G network slicing allows operators to segment multiple virtual end-to-end networks out of the same 5G infrastructure, namely, network slices. The 5G end-to-end network slices require the collaboration of RAN, core and transport networks. As the carrier that connects wireless and core network slices, the transport network is a major part of end-to-end network slices. Increasingly differentiated slice applications are in urgent need of the slicing technology that can accurately address the needs of differentiated applications.

Slicing Architecture for Transport Network

ZTE's optimized transport network slice solution based on Flex Algo provides the precise transport network slicing ability, meeting the needs of precise slices, precise slice isolation, and flexible slice deployment for transport networks. Its overall architecture is shown in Fig. 1. The optimized slice solution can create various Flex Algo

slices according to the SLA requirements of different users and direct services to Flex-Algo slices.

Flex-Algo slices have a flexible mapping relationship with the underlying transmission resources. Resources of different numbers, types and granularities are allocated to create Flex-Algo slices with different bandwidth, delay and isolation characteristics, and they can be dynamically adjusted and optimized according to the load of the slices.

Precise Slicing Granularity

ZTE's transport network slice solution provides transmission resources of different granularities such as physical ports, 5 Gbps FlexE subrate, and megabit-level channels.

Resource Granularity Based on FlexE

The FlexE technology decouples physical port bandwidth and service rate by dividing timeslots in IEEE standard rates above 50GE and provides Nx5Gbps sub-rates or channelized interfaces. In order to meet the needs of different SLA requirements, a physical link can be divided into multiple FlexE VEIs, or multiple low-rate ports are bound into a FlexE group to flexibly match bandwidth resources needed by the services.

Megabit-Level Resource Granularity Based on Fine-Grained Timeslots

To secure flexible bandwidth for vertical industry applications, the existing resource granularity can be further divided to Megabit-level granularity based on some 5 Gbps FlexE VEIs or sub-interfaces. Each slice is identified with the network topology and allocated with forwarding queue resources to deploy the targeted QoS scheduling policy and offer precise megabit-level resource granularity.

With small-granule resources, the transport network can be accurately sliced according to service needs. It accurately carries various services while improving network resource utilization.

Precise Slice Isolation

Slice isolation mode varies from service to service. The services requiring high security and isolation usually employ hard isolation slices, that is, the services are exclusive to the underlying resources and the slices have the characteristics of physical isolation. The services with latency and jitter requirements adopt soft slice isolation, that is, the services can share underlying network resources. In ZTE's transport network slice solution, Flex-Algo is

completely decoupled from the underlying resources, and can be flexibly mapped with FlexE resources, thus supporting soft and hard isolation slices. The following describes the FlexE sub-port mode.

Hard Isolation Slice

In this scenario, FlexE, as the underlying network resource isolation technology, divides timeslots physically isolated from each other at the physical layer, and configures the affinity attributes of related VEIs and links. The upper Flex-Algo maps to underlying specific FlexE resources through the affinity attributes in FAD to exclusively occupy FlexE sub-port resources, thus enabling hard isolation slices based on tenants or services.

Soft Isolation Slice

In addition to the 1:1 mapping between Flex-Algo and underlying resources, ZTE's transport network slice solution also supports their N:1 mapping relationship, with multiple FAs sharing a FlexE sub-port resource. Based on the unified underlying resources, different FAs can have different metric types and different metric types represent different SLA goals, which can meet the need of transmitting diverse service slices.

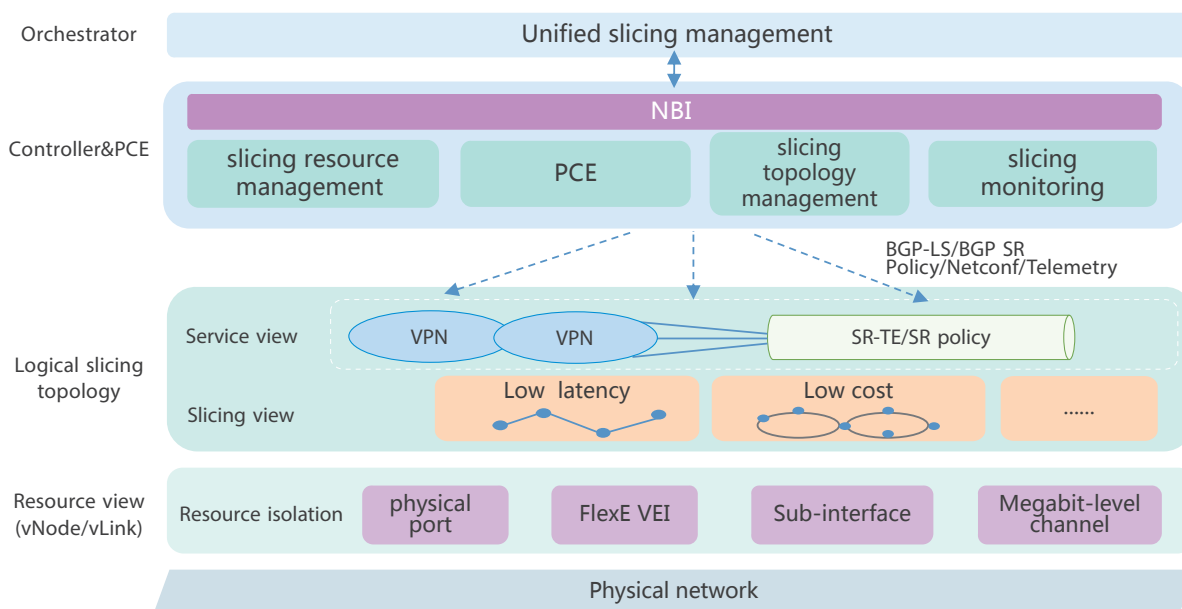

◀ Fig. 1. ZTE's transport network slicing architecture.

Flexible Slice Deployment

ZTE's transport network slice solution provides good support for operators to deploy their industry applications and achieve a two-level slicing. First, operators can have a basic resource planning of their infrastructure networks, divide them into multiple isolated FlexE physical resources for ToB, ToC and third-party applications, and build level 1 virtual transport network (vNET) for enhanced lease service product competitiveness, greater value-added profits, and reduced operating costs. Second, customers can choose to further slice based on the networks leased by themselves, set up a new vNET based on the Flex Algo view to suit their own diverse needs or lease the vNET to secondary customers, and to plan and manage their slice networks according to the nature of services being carried. The typical slice deployment scenarios include operator's own ToC service, highly secure self-operated ToB service, and large industries or third-party operators (Fig. 2).

- **Operator's own ToC service:** This service has a low priority and can be carried through the default FA, and the operator can directly control its own network.
- **Highly secure self-operated ToB service:** A two-level slicing is created based on specific FlexE basic resources, and the special FA is divided for exclusive resource isolation and small granularity. The management and control authority is set for leased small and medium-sized enterprises, and they only have the logical view permission.
- **Large industries or third-party operators:** A two-level slicing is created based on specific FlexE basic resources, which allows a FA to exclusively occupy

underlying resources or enables multiple FAs to share them. The large industries or third-party operators have logical view and partial service configuration permissions.

End-to-End Precise Slice Distribution

The transport network is a part of 5G end-to-end network. When deploying end-to-end slice services, it selects proper slice types according to the needs of 5G slice applications to achieve precise slice distribution through the 5G end-to-end network slice management function (NSMF) and the transport network sub-slice management function (NSSMF).

NSMF orchestrates end-to-end slice services in accordance with slice applications, and delivers the orchestration results to professional sub-slice management functions. Among them, the parameters sent to the transport sub-slice contain slice topology information, slice isolation requirements, and slice SLA parameters. The transport NSSMF chooses the appropriate slice type based on this information and creates the corresponding slice services.

Transport Network Slicing Applications

To study the applications of transport network slicing in 5G vertical industries, ZTE has extensively cooperated with many Chinese and overseas operators and vertical industry customers to jointly explore deployment policies and overall solutions for precise and flexible transport network slicing applications.

ZTE and China Telecom have commercialized the FlexE hard slice technology on a large scale in the existing network, and put forward the

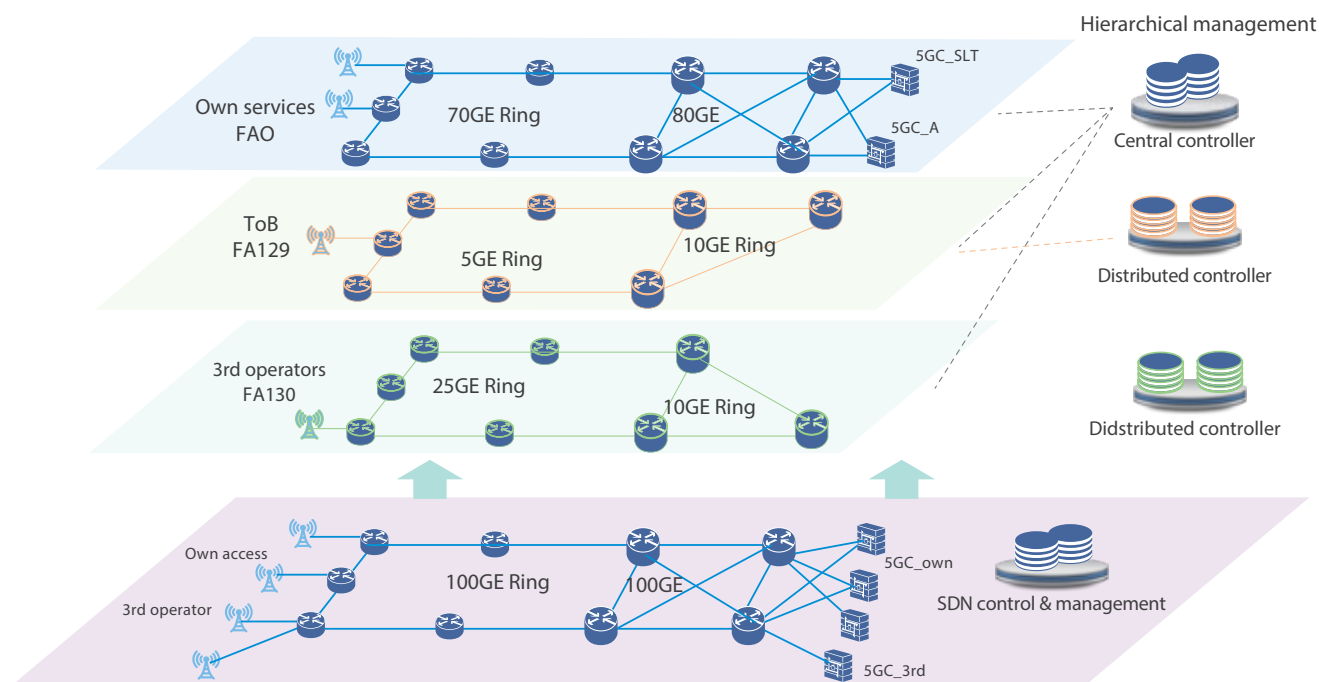

▲ Fig. 2. Typical slice deployment scenarios.

precise and flexible slicing application solution. The FlexE hard isolation slicing pipeline technology divides the physical network into two hard isolation slice vNets (ToB and ToC) according to different scenarios, which carry high-priority services for 5G industries and services for public users respectively. The ToB slice network is scheduled according to priority queuing (PQ). The solution isolates resources between network slices and makes statistical multiplexing of network resources within slices. It transmits high-priority services accurately and stably while increasing network resource utilization.

ZTE has also studied the applications of 5G smart grid and analyzed the requirements for the transport network in various scenarios, such as power distribution network automation, distributed energy,

precise load control, line monitoring, and energy consumption detection. To meet the needs of power grid for safety isolation, latency and bandwidth, multiple slices can be flexibly planned to transport hard isolation exclusive slices and soft isolation shared ones. The production area adopts the end-to-end exclusive hard isolation slice mode. Through independent slice identification and queue resource slice allocation, resource-exclusive small-granule transport slices are created on FlexE hard slices to provide a highly reliable slice channel with zero packet loss.

ZTE will continue to study the applications of 5G precise and flexible slicing in vertical industries, analyze their development trends and communication needs, and promote the deep integration and common development of 5G transport network technologies and vertical industries. **ZTE TECHNOLOGIES**

Constructing a New-Generation 5G Transport Network Based on SRv6



Zhang Baoya

Chief Engineer of ZTE 5G
IPRAN Planning

The carrier-class transport network has experienced various network technologies such as SDH, PTN and IP RAN. With the development trend of all-IP mobile base stations and large bandwidth, the IP/MPLS technology has been widely used. However, cloud-based 5G 2C and 2B services require the network to provide flexible links, accurate and controllable paths, and precise awareness, and the great development of SDN requires an open, programmable, and end-to-end collaborative network to enable differentiated services and agile OAM. These requirements are difficult to meet with the traditional MPLS and segment routing MPLS (SR-MPLS). Therefore, SRv6 comes into being to meet new business requirements and emerge as the best technology choice for a new-generation carrier-class bearer.

Carrier-Class PTN Review

Since the birth of TCP/IP in the 1980s,

the development of packet transport network (PTN) technology can be divided into two stages:

- The first stage is the IP/ETH era that promotes the Internet revolution. The network technology is based on IP+Ethernet to serve best-effort services, with poor transport quality, low reliability and limited network scale. It mainly serves public services, and its base stations generally adopt SDH transport mode.
- The second stage is the IP/MPLS VPN era. IP/MPLS provides connection-oriented services that can ensure carrier-class QoS and reliability. With the innovation of all-IP mobile technologies in the 3G era, the basic mobile backhaul network technologies have also changed from SDH to PTN. Key technologies such as PTN E2E services, millisecond-level OAM inspection and reliability, graphical NM, strong QoS and 1588v2+Sync-E have been widely recognized by the industry.

However, IP/MPLS LSP relies on distributed protocol route calculation or manual static planning. VPN supports various service protocols, but it is not suitable for the development of SDN due to its layered services, complex deployment and inconsistent technology.

SR-MPLS Shortcomings

SR-MPLS can satisfy the partial centralized route calculation of cloud networks and overcome deficiencies of the traditional LSP technology. However, SR-MPLS is essentially the MPLS forwarding plane and has shortcomings in the cloud-network era.

- SR-MPLS cannot scale for it uses 4-byte MPLS labels to identify the paths.
- SR-MPLS cannot extend LSP to the cloud, which is not good for cloud-network synergy or for access of tunnels to the cloud.

- SR-MPLS cannot adapt to non-MPLS networks as it belongs to the MPLS family.

The next-generation carrier-class transport network needs to provide precise service and network awareness. Moreover, IPv4 addresses are running out and new-generation service terminals, RAN and core networks are transforming to IPv6, so carrier-class transport networks also need to evolve to IPv6.

SRv6 Benefits

SRv6 comes out to overcome the limitations of SR/MPLS. It uses IPv6 addresses as path node data, and its path list data is placed in the IPv6 header, compatible with traditional IPv6 forwarding. In addition to identifying node/link data, SRv6 header can also support customized extension data



to meet future new needs such as in-band measurement. SRv6 takes IP addresses as its protocol stack to adapt to end-to-end orchestration of future cloud-network synergy services.

SRv6 supports traffic engineering (TE), robust scalability, and compatibility with IPv6, providing a technical foundation for future fixed-mobile convergence (FMC) and unified IP forwarding. As instu-OAM in SRv6 has been drafted in the IETF, SRv6 can offer millisecond-level service awareness by multi-functional network nodes, fit the development of intelligent routing, and guarantee carrier-class in multiple dimensions. Driven by 5G and cloud services, a new-generation carrier-class transport network has entered the SRv6 era.

Transition to SRv6

SRv6 adapts to future network development, but it also has shortcomings. On the one

hand, the SR SID list adopts the 16-byte IP address for identification, which has low forwarding efficiency and high requirements for forwarding chips. Only a few chips in the industry can achieve 10+ layers of label encapsulation. Now the IETF is studying the SRv6 label compression solution that can greatly solve the problem of label byte depth.

On the other hand, unlike wireless networks that use one-generation technologies for one-generation networks, one-generation carrier-class transport networks carry multi-generation services. Some devices in the transport network support SRv6, but some do not. Therefore, it is necessary to provide a transition solution for the coexistence of MPLS and SRv6, and also to further study its transport approach. The mainstream solutions include MPLS and SRv6 splicing solution, dual-plane solution, and overlay solution.

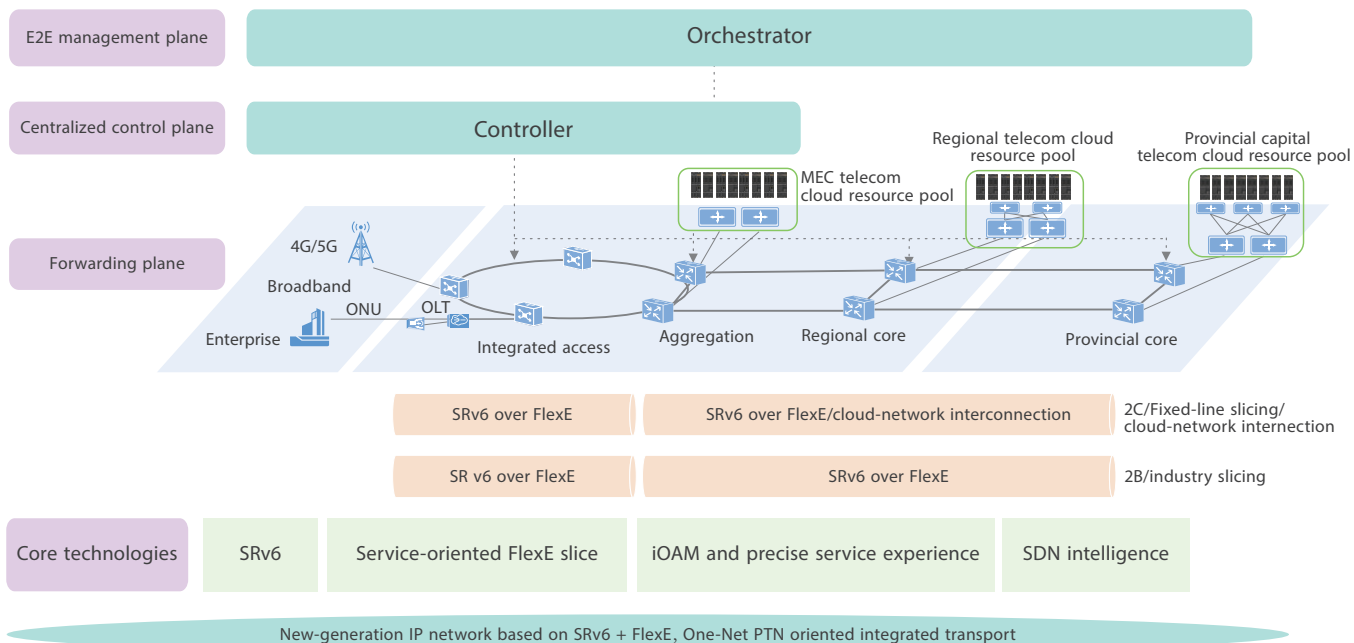

▲ Fig. 1. A new-generation carrier-class transport network based on SRv6.

SRv6 promotes the unification of FMC and cloud-network technologies in the future. It is a key technology to achieve service differentiation, real-time network awareness, and service isolation.

Building a Carrier-Class SRv6 Transport Network

The basic SRv6 protocol is mature and ready for commercial deployment. With the development of 5G and cloud services, building a new-generation carrier-class transport network based on SRv6 (Fig. 1) for new-generation business development has become a hot topic in the industry.

Commercial Trials of ZTE SRv6

ZTE has been studying SRv6 since 2017, and its SRv6 has been deployed commercially on a large scale. The company has participated in several SRv6 commercial trials:

- ZTE developed the SRv6 lab test for Japan's Softbank in 2018, and participated in China Telecom's centralized procurement test in 2019 where SRv6 functions were ready.
- ZTE completed China Telecom's STN SRv6 interoperability test in the lab in 2020, and carried out a large scale upgrade of the existing networks. This helped China Telecom build the world's largest SRv6 commercial network, deploy 2B/2C slices, introduce MPLS/SRv6 splicing and dual-plane technologies, and achieve the

integrated commercial deployment of IP RAN1.0 and STN.

- ZTE participated in China Telecom's STN-based new MAN trial in 2020. The basic SRv6 protocol was used to achieve FMC transport. ZTE took the lead in implementing unified access and transport of fixed-line and 5G services through STN in Wuxi, Jiangsu Province.

Conclusion

SRv6 promotes the unification of FMC and cloud-network technologies in the future. It is a key technology to achieve service differentiation, real-time network awareness, and service isolation and meets the needs of future service development. SRv6 has become the core technology of the next-generation carrier-class intelligent transport network. ZTE's 5G IP RAN 9000E has been widely deployed by China Telecom and upgraded to support SRv6. In China Telecom's new MAN trial oriented to FMC, the 5G IP RAN 9000E can be interconnected with the SRv6 of other vendors to carry integrated FMC services. ZTE can also support SRv6 at the access layer, allowing existing network products to smoothly upgrade to SRv6. **ZTE TECHNOLOGIES**

Enabling Cloud-Network Synergy with Precision 5G Transport Network



Ma Yuxia

Planning Director of ZTE
BN Products

5G, together with cloud computing and big data technologies, fully accelerates the digital transformation of the vertical industry. Vertical applications are diversified and have differentiated requirements for the network. A complete user service needs to traverse the entire network, connecting the network and cloud. ZTE's precision 5G transport network solution harnessing cloud and network synergy can meet the diversified requirements of various industries.

New 5G Transport Network

Service cloudification and technology innovation drive operators to shift from operating telecommunications services to providing integrated cloud services. Meanwhile, cloud services brought by cloud-network synergy promote network transformation.

Enterprise Cloud Migration

With the rise of the digital economy, all vertical industries are carrying out a digital transformation, which is driving enterprise cloud migration. Operators are expanding their cloud service offerings year by year. Fast cloud access and flexible scheduling of cloud resources require an agile and intelligent network. That

is to say, the network needs to be automated and programmable for fast service provisioning and differentiated service guarantees.

Cloudification of Core Network

5G brings in cloud-based architecture and technologies, and the cloudification of the core network provides new service capabilities such as network slicing and edge computing for consumers, application providers and vertical markets. The 5G transport network needs to allow for on-demand transmission of 5G services that cover a large area and require multiple distributed edge data centers to the cloudified 5G core network. Therefore, the transport network needs to prioritize the cloud requirements, and work with the radio access network and core network to enable end-to-end network slices and provide low-latency network connections for edge computing.

Fixed Mobile Converged Transport

Traditional home broadband and mobile services will gradually migrate to the cloud, which makes the unified transport of home broadband and mobile services possible. Meanwhile, with the network device virtualization trend, the home broadband transport device BRAS deployed on the MAN first separates the control plane from the

forwarding plane. The control plane implements cloudification and the forwarding plane provides centralized pooling. Therefore, it is possible to integrate the traditional fixed and mobile networks to carry home broadband, mobile, government & enterprise, and various cloud services through a single network.

ZTE proposes the precision 5G transport network solution to precisely match with various requirements of cloud and network development.

Technologies for Precision 5G Transport Network

The precision 5G transport network solution is based on a series of new technologies and continuous improvement of network equipment software and hardware. The SRv6, FlexE and in-band OAM are cornerstones of the precision transport network.

SRv6 for Service Agility and Network Simplification

SRv6 simplifies protocol complexity and network operations, reduces resource occupation, enhances path adjustment and control capabilities, increases scalability, and finally facilitates network capability exposure. SRv6 also has the advantages of IPv6 such as massive address resources. The basic architecture and encapsulation format of SRv6 have been standardized, while SRv6 header compression, protocol extension and traffic engineering are being standardized.

FlexE for Deterministic Bandwidth and Latency

Flexible Ethernet (FlexE) is an interface technology that enables larger bandwidth and channelized sub-rate transport. On the one hand, FlexE can bind multiple Ethernet interfaces to obtain larger interface bandwidth. On the other hand, TDM-like rigid pipes are provided to ensure strict isolation between services and guaranteed bandwidth and latency. Therefore, the 5G transport

network employs FlexE to implement hard pipe slicing and flexible bandwidth allocation. It can be integrated with SDN technology to achieve dynamic network adjustment.

In-Band OAM for Network and Service Status Perception

In-band OAM measures end-to-end and hop-by-hop packet loss and latency of real service flows. Compared with the traditional detection technology, in-band OAM allows operators to know real-time network status by performing real-time SLA monitoring, meeting daily OAM monitoring requirements. It also supports rapid fault localization and isolation, and with the coloring solution (RFC8321) avoids the extra overhead or just incurs a slight increase of overhead.

Precision 5G Transport Network Empowering Vertical Industries

The precision 5G transport network provides a variety of key capabilities, including precise bandwidth/latency guarantee, precise service delivery, precise path control, precise service detection and precise service security guarantee, to facilitate service innovation in various industrial scenarios and improve the precision service capabilities of the cloud and network.

Precision Pipe

Network slicing is a key feature of 5G end-to-end networks that enables independent end-to-end logical networks on the same physical network to fulfil diverse service requirements. Considering the large differences in service requirements and network costs, the transport network provides different slicing modes, including hard and soft slicing.

Hard slicing is based on physically rigid pipes, such as FlexE and megabyte-level small-granularity hard pipe technologies.

ZTE's full-series products with different port speeds (25/50/100/200/400GE) support FlexE, and exclusively allow 25GE FlexE. In addition, ZTE's in-house chips integrated with FlexE have low latency and low power consumption without increasing costs. The minimum 5 Gbps FlexE granularity is relatively large for some applications. Therefore, ZTE proposes the megabyte-level rigid pipe technology to guarantee the service bandwidth and latency at any granularity. A forwarding plane can use hard slicing to provide strict isolation for guaranteed service bandwidth and latency, that is, zero packet loss and low jitter in case of congestion.

Soft slicing is based on statistical multiplexing, such as VPN, SRv6 tunnel and QoS scheduling. Soft slicing makes efficient use of the bandwidth to maximize network resource utilization.

In practical applications, soft and hard slicing can be combined and deployed on demand to implement customized transport slices (Fig. 1) to meet personalized requirements of SLA-differentiated services, provide flexible, precise bandwidth and latency services and realize precise network operation, helping operators expand industry applications.

Precision Management and Control

Network OAM in cloud and network

synergy scenarios faces the challenges from diversified industrial application services and managing ultra-large-scale network connections. Therefore, the 5G transport network in support of cloud and network synergy must be automatic and intelligent. ZTE proposes the hierarchical management and control architecture and platform to implement precision 5G transport network management and control together with the agile forwarding plane.

Based on the architecture for unified orchestration and distributed management and control, the hierarchical management and control platform enables automation and intelligence by layers. The domain-based management and control layer supports batch configuration and automated configuration of unnecessary parameters, which changes the original point-by-point manual configuration mode to a highly automated one with minute-level service provisioning. This new mode provides multiple service templates, which can be selected flexibly based on the needs during service provisioning. Combined with the big data analysis and AI algorithms, it predicts network traffic and quality, and implements active OAM and intelligent management and control. The unified orchestration layer is integrated with an

Fig. 1. On-demand combined deployment of soft and hard slicing.

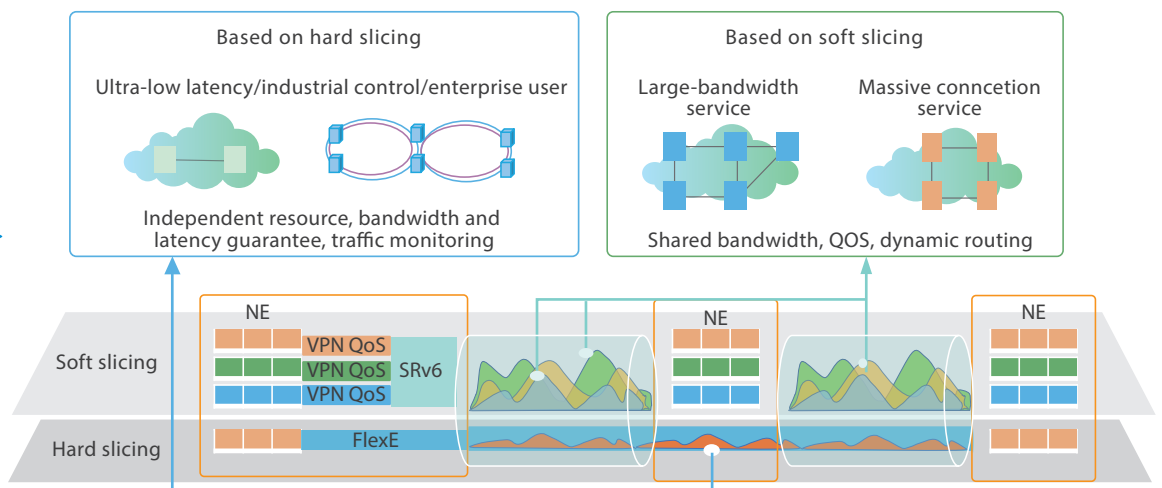

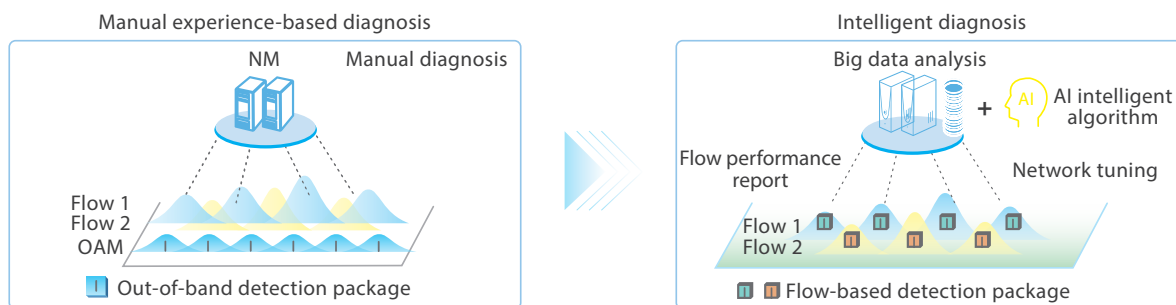

◀ Fig. 2. From manual diagnosis to intelligent diagnosis.

independent big data platform to accurately identify customers, and provide proactive analysis and guarantee for business logic implementation and service quality. Thus, “customer intelligence” and end-to-end service automation can be achieved.

SRv6 is introduced into the network forwarding plane to provide unified service transport. It achieves agile service provisioning with only the need for head-end configuration, and provides programmable service paths and application-level SLA.

The hierarchical management and control plane in combination with the agile forwarding plane implements intelligent network OAM and flexible end-to-end service deployment and adjustment.

Precision Diagnosis

Traditional network diagnosis, which mainly relies on manual operation, has such problems as long processing time and low localization accuracy. ZTE proposes the intelligent diagnosis based on in-band OAM, Telemetry and AI algorithms to improve the network diagnosis efficiency, as shown in Fig. 2. In-band OAM is used to provide real-time visibility into network performance, real-time perception of network status, and rapid, precise fault localization. With its patented intelligent Telemetry data collection technology, ZTE also performs big data analysis to realize intelligent, dynamic traffic and path optimization.

The intelligent diagnosis achieves precise

per-flow fault detection, reporting with millisecond accuracy, accurate fault localization and intelligent optimization, improving resource utilization and OAM efficiency.

Precision Security

Guaranteeing user data security is one of the goals of the transport network. ZTE 5G transport solution continuously improves the work flow in each phase of the network life cycle to guarantee service data security. For example, a hardware acceleration engine is added to a line card to perform direct protection switching in case of a hardware fault. Without the involvement of CPU, it can implement millisecond-level protection switching. The acceleration algorithm is also used to accelerate the convergence speed of routing protocols. Moreover, the equipment is upgraded without service interruption, avoiding upgrade restarts.

Summary

The future-oriented 5G transport network needs to accommodate the trend of service cloudification and cloud-network synergy and form a new unified transport plane for mobile, home broadband and government & enterprise services. Meanwhile, the precision 5G transport network will further help operators improve their cloud-network precision service capabilities so that 5G applications and innovative cloud and network applications can flourish in the new era. **ZTE TECHNOLOGIES**

Research into the Deployment and Application of Intelligent Time Network



He Li

Chief Engineer of BN
Product Synchronization
Technology, ZTE

China Mobile carried out a large-scale deployment of time networks in the 4G era. The time network and the PTN/IPRAN mobile backhaul network are physically one network. The main problems are the complexity of clock network planning, low configuration efficiency, and lack of an effective fault isolation scheme for large-scale networking. The clock fault in one area may affect the clock service in another unrelated area, so it is difficult to locate the fault. The integrated intelligent time network solution has been developed to address the issue of large-scale deployment. The solution breaks the restriction that the time network and the service network need to share the same network in the 4G era. The core idea is to deploy a single-fiber bidirectional private time network on the core aggregation ring and use base stations to backhaul GNSS signals at the access network. The time network is divided into the domains that are managed and controlled by big data or AI technologies.

Key Technologies

The intelligent time network uses an

intelligent management and control system to implement hierarchical fault isolation and intelligent fault analysis, which can solve the deployment and location problems of large-scale time networks.

Time Network Division

The networking algorithm of the time network is dynamically generated in real time by the best master clock (BMC) algorithm with adaptive meshing.

The undivided time rings synchronize the time according to the configured master/slave time priorities, and the time rings of all devices are interlinked. When an access ring device fails, for example, when its priority is changed to the highest or higher priority, the time of the lower-priority device in the local access ring, other access ring or the aggregation core ring will follow the time of the faulty device. The fault affects widely, and it is easy to cause repeated network oscillation, so it is difficult to locate the fault.

To accelerate the fault location and restrict the impacted scope, the network can be divided into areas by levels. The time source can be moved down to the place where the aggregation and core networks meet to implement multi-source

multi-area division physically, or the network can also be divided logically, with some transport nodes abstracted into virtual time source injection points (Fig. 1).

According to the network layer where the nodes are located, the network management controller divides the time network into core aggregation, common aggregation, and access ring time rings. Unidirectional timing between different layers is implemented in the following direction: core aggregation → common aggregation → access ring. The ring at a lower layer cannot provide time to a higher-level ring, which can isolate faults between access rings. The fault and impacted scope at each layer are clear, which makes it easy to use the BMC algorithm manually to isolate faulty areas quickly.

Automatic Planning

Automatic planning refers to automatically calculating and planning active and standby

clock synchronization topologies of all or specified NEs in accordance with the physical topology and NE clock synchronization attributes, solving clock time configuration according to the rules and eliminating the difference between new and old devices to implement automatic port selection. For example, a single-fiber bidirectional path is preferred for network construction.

When the network changes, the changed network area is automatically synchronized and reconfigured according to the changed topology to achieve the minimum change, and the existing synchronization configuration in other areas is not affected. The automatic planning of the time network is efficient, simple and easy to configure, which reduces the complexity and human errors of network planning.

Single-Fiber Bidirectional Time Transfer

Above the aggregation ring of the

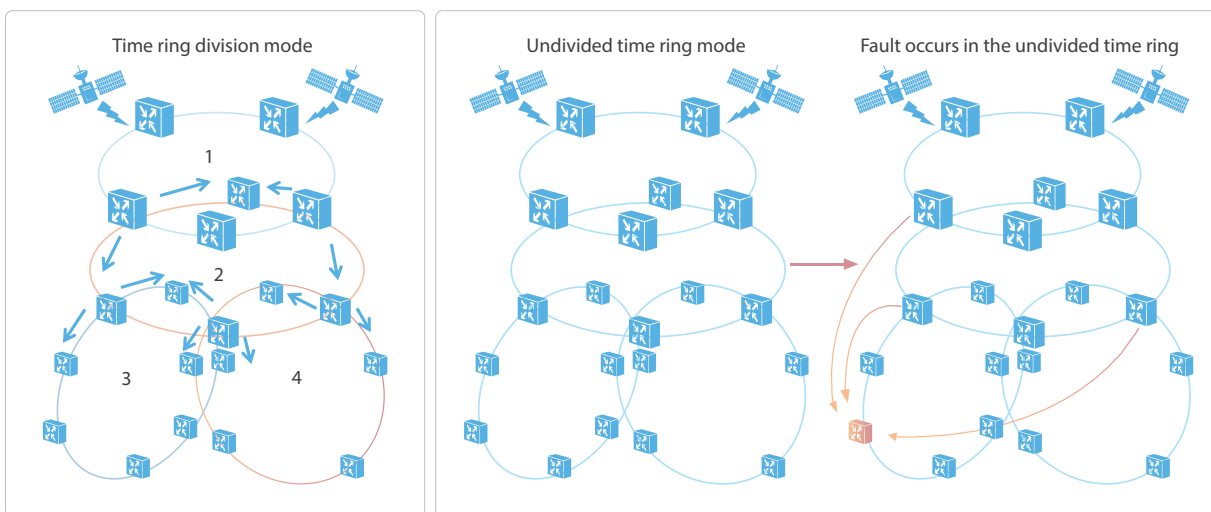

◀ Fig. 1. Time network division.

transport network, the long-haul, OTN and packet devices may coexist, and their time precision directly affects that of the downstream access ring. Dedicated links and GE/10GE single-fiber bidirectional optical modules are used to form the special clock time ring above the aggregation layer. It can not only reduce the latency deviation caused by fiber asymmetry, but also avoid the uncertain errors caused by coherent optical modules. This ensures the interconnection between OTN and packet devices while enhancing its stability.

After the single-fiber bidirectional transport is introduced, the latency difference caused by long-haul transmission of different wavelengths in the optical fiber should also be considered. Take the GE 40 km optical module solution as an example. The wavelength range of lasers defined by the IEEE standard is 1310 to 1490 nm, and the dispersion coefficients in 1310 nm and 1490 nm windows are different. If G.652 optical fibers are used and the corresponding transport latency difference is ± 1.28 ns/km, the 40 km transmission will result in a time difference of ± 25.6 ns. Therefore, when single-fiber bidirectional optical modules are used for networking, if there is no compensation, the time error caused by the accumulated wavelengths in the existing network cannot be ignored under the improper matching relationship.

Because the relationship between wavelength and latency is linear, the latency deviation can be calculated by automatically estimating the latency when the wavelength is known, so as to offset the error caused by the wavelength deviation.

The management and control equipment automatically select a single-fiber bidirectional path according

to the existing network equipment.

Base Station Time Backhauled to Transport Network

Wireless base stations use GNSS and 1588V2 for time synchronization at the air interfaces. To ensure stable and reliable synchronization, the base stations often activate the two technologies at the same time to protect each other. The system backhauls the difference between the time obtained by GNSS and by 1588 to the transport equipment at the access layer and reports it to the transport network management and control system. The controller can analyze the data of upstream and downstream sites to infer the performance of base stations or the transport network and further locate the root cause of the fault.

The comparison information between the satellite and transport equipment backhauled by the base station provides the absolute time difference between the base station and the ground. The transport access equipment can calculate the reliability of the current equipment time according to the information obtained from multiple base stations and upstream and downstream nodes. The comparison information can also be combined with other clock time alarms as well as configuration and performance data to form important feature data of intelligent fault diagnosis, which is used to calculate device status in the network without access to GNSS.

Intelligent Fault Diagnosis of Clock Time

The intelligent fault diagnosis of clock time includes fault identification, fault location and root cause determination. The

basic idea is that the network management controller uses clock time-related configuration, alarm and performance data to carry out big data analysis and intelligent fault diagnosis.

Fault Identification

Fault identification of the clock time network is to identify whether the clock time network is faulty using the knowledge graph or AI technology based on the collected topology structure of the clock time network and the configuration, alarms, and performance feature data of clock time at each NE node.

AI fault analysis is an application of machine learning in communication networks, which is suitable for fault analysis with less fuzziness in complicated networks. Using the AI technology to identify the faults of a clock time network involves three steps. First, collect the marked sample data of the clock time network and convert it into a train set. Second, establish the corresponding AI model. Finally, train the model using the train sample set, so that the model has the capability of identifying clock time network faults.

ZTE has two technical solutions for fault location: fault location based on the fault dependency graph and rules, and fault location based on the graph neural network.

- **Fault location based on the fault dependency graph and rules:** This solution needs to establish the fault dependency graph based on the existing clock time configuration and actual clock and time paths. To locate a fault, the system searches for the faulty entity node based on the established fault dependency graph and the node judgement rules. In general, the faulty entity node at the bottom layer of the dependency is the location of the fault

to be determined.

- **Fault location based on the graph neural network:** The graph neural network is a machine learning connection model. It captures the dependency of the graph through the message transfer between the nodes of the graph, and extends the deep neural network from dealing with traditional unstructured data to higher-level structured data. The fault location based on the graph neural network uses not only the feature data of its own nodes, but also the feature data of adjacent nodes. In this way, more fault feature data is collected, and the accuracy of fault location is higher. The implementation of fault location based on the graph neural network involves four steps. First, define fault location scenarios abstractly, and transform the fault location issue into the node classification issue based on the graph neural network. Second, set up an end-to-end node classification model based on the graph neural network needs. Third, collect the marked sample data of the clock time network and convert it into a train sample set. Finally, train the established fault location model based on the graph neural network, so that it has the capability of locating the faults.

Conclusion

With rich experience in large-scale deployment of PTN time networks in the 4G era, ZTE's intelligent time network solution has been gradually trialed in existing networks of Jiangsu Mobile, Fujian Mobile and Beijing Mobile, and has been significantly improved in iteration. The solution has addressed the issues of large-scale time network deployment and troubleshooting in the 4G era, paving the way for constructing a 5G transport time network. **ZTE TECHNOLOGIES**

Intelligent OAM of 5G Network



Xiao Hongyun

Planning Director of ZTE
BN Product Solution

5G is a network centered on customer experience, which needs to meet different scenarios and differentiated industry requirements in a timely manner. These requirements include not only large bandwidth, low latency and high security, but also efficient network construction and fast service provisioning, real-time network status awareness, fast fault diagnosis, precise traffic prediction and optimization, and system openness and reliability. Traditional telecom technologies, architecture and OAM models are difficult to meet these needs, so new concepts and technologies have to be introduced. With the industry's exploration in the fields of AI, big data, cloud computing and SDN&NFV in recent years, intelligence has been widely regarded as the core capability of 5G and future networks.

Based on a deep understanding of 5G wireline network needs and strong technical strength in the fields of SDN, machine learning, big data, knowledge graphs and intent networks, ZTE has innovated Athena 2.0, the intelligent network solution that allows for an intelligent closed-loop OAM throughout the lifecycle of a 5G wired network. The solution addresses the needs of network development and OAM in the 5G era and continues to evolve network intelligence based on advanced architecture to adapt to rapid network development and accelerate the arrival of autonomous networks.

Athena 2.0 Architecture

Athena 2.0 consists of two parts: a new-generation intelligent management and control system (ZENIC ONE) and a wired equipment network with super capabilities (Fig. 1). ZENIC ONE, the core of Athena 2.0, gives intelligence to the telecom network and functions as a network brain. The intelligent OAM is fulfilled at the management and control layer.

ZENIC ONE based on ZTE's self-developed cloud native platform contains three engines (intent engine, control engine, and awareness engine) and two platforms (BigData and AI). The three engines cooperate with each other to form an intelligent closed loop, which is supported by the two platforms.

The intent engine converts the user's intent input by voice and text into a network intent expression model and carries out scheme design and pre-verification. The control engine involves network orchestration, control and management service. It enables cross-domain and cross-vendor collaboration, offers fast end-to-end service distribution, and supports multiple networks such as IP, IPRAN, PTN, SPN and OTN. The awareness engine improves the ability and efficiency of network optimization through correlation analysis and in-depth mining of massive data, truly realizing end-to-end network optimization oriented to service and customer experience. With continuous optimization of user experience, it

greatly enhances the ability of traffic optimization, early warning and problem prediction.

The BigData platform is the network data foundation of Athena 2.0 and also the twin data network of the physical network. It delivers rich data services at all levels such as structured and unstructured data services as well as knowledge graphs based on diagram database.

The AI platform is a basic platform that provides AI algorithms and services for various network services and components. It has a powerful AI framework and a variety of algorithms and interfaces, which are used for other parts of Athena 2.0 to improve its intelligence. It also makes continuous optimization based on the data on the BigData platform.

Intelligent Closed-Loop OAM

The Athena 2.0 solution enables

intelligent closed-loop OAM throughout the lifecycle of a 5G wired network through rapid network construction, intent-based service provisioning, precise service awareness, automatic service recovery, intelligent fault diagnosis, and intelligent prediction optimization (Fig. 2).

Rapid Network Construction

In the traditional OAM, network construction or expansion requires manual and careful network design and planning, followed by site-by-site device activation, but there are the problems of low activation efficiency, high labor investment, and error-proneness. The function of rapid network construction can effectively solve the above pain points. First, it supports automatic deployment. After installation, the device automatically discovers network elements, boards and links and generates network topology without manual operations. Second, it globally plans logic resources such as

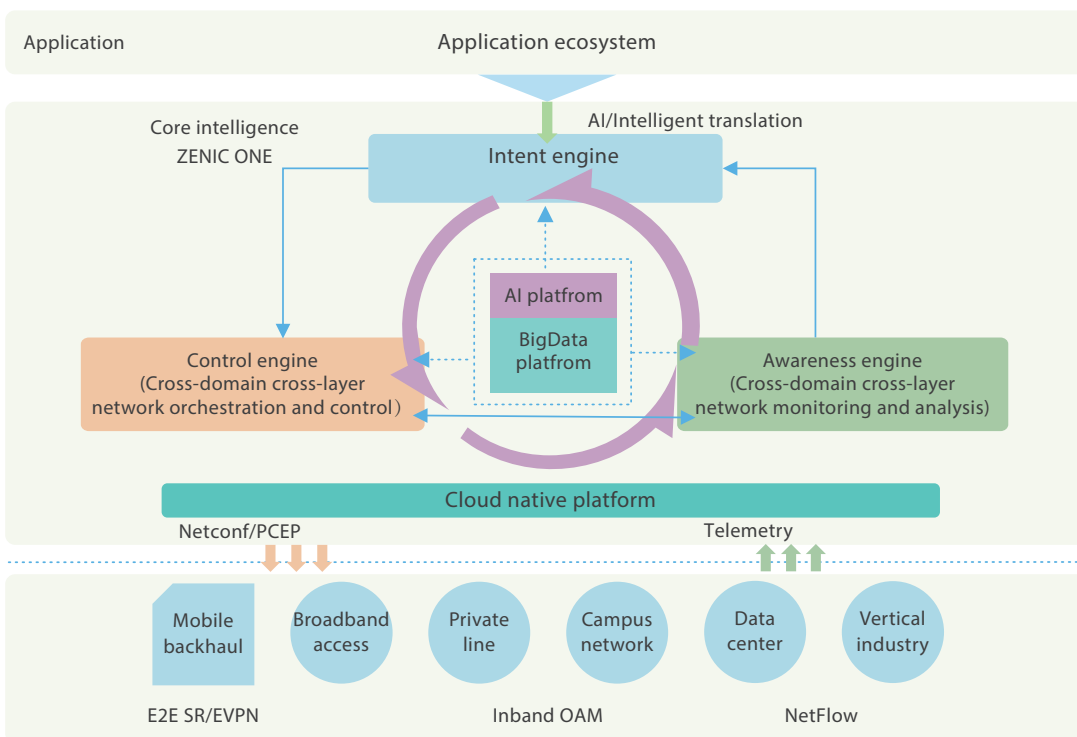

◀ Fig. 1. Athena 2.0 architecture.

Fig. 2. Athena 2.0 used for intelligent closed-loop OAM.

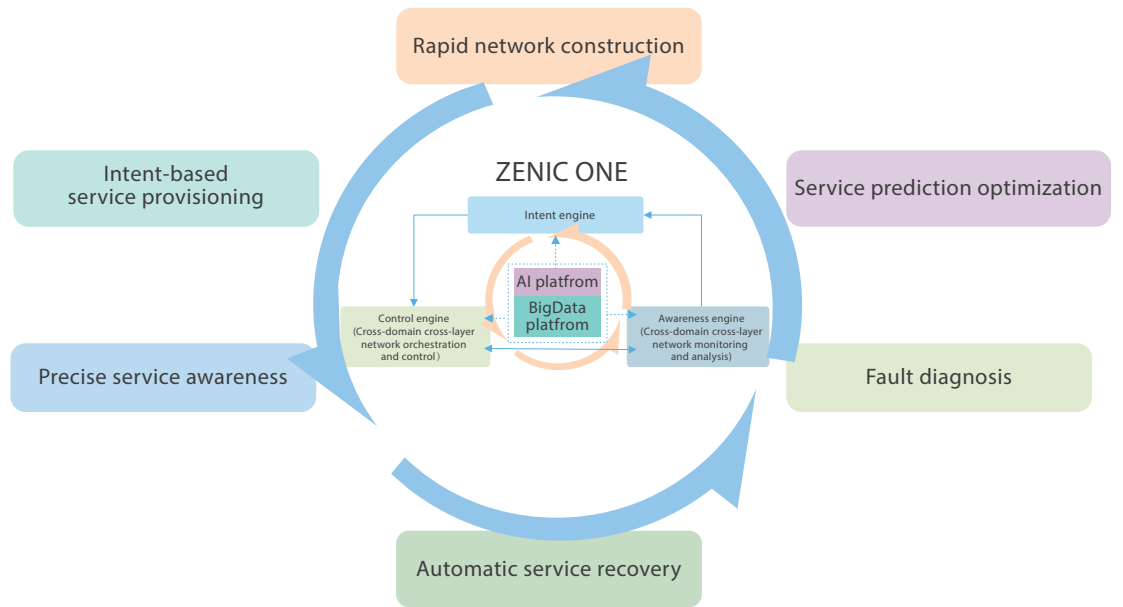

routing domains, IP and network bandwidth, and forms different configuration templates for different scenarios. The user automatically creates configuration data based on the existing templates and sends them to devices in one click. The rapid network construction function reduces the complexity of site commissioning and improves the efficiency of network activation by 70%.

Intent-Based Service Provisioning

The traditional service provisioning requires users to configure tedious service parameters, which results in large workload, long provisioning time, error-prone operation and high OAM costs. The function of intent-based service provisioning is extremely simple to operate. The user only needs to select the service scenario and enter necessary information (service add/drop devices and ports), and then the system will automatically recommend the service-level agreement (SLA) data (bandwidth, protection attributes, and restoration attributes) according to user intents and history input information, with a friendly interface. After user selection, the system will automatically form multiple service solutions in line with the user's intent and give a

recommended solution. Then the system converts the solution selected by the user into specific configuration information. The control engine verifies the chosen one and distributes it to related devices for service provisioning. The intent-based service provisioning is extremely simple to configure and visible in the entire process, which increases the efficiency of service provisioning by 80% and significantly enhances user experience.

Precise Service Awareness

The function of precise service awareness implements end-to-end real-time monitoring of various services. Inband OAM technology is used to collect statistics on quality data such as packet loss, delay and jitter of traffic streams and report them to ZENIC ONE in seconds through Telemetry. The BigData platform performs data storage and correlated processing, and the awareness engine fulfills realtime analysis and evaluation. If a certain quality feature of the service is found to exceed a threshold, the system will automatically trigger accurate monitoring, graphically show the monitoring results, pinpoint the deteriorated feature and give an early warning, so that the user can carry out targeted treatment, better

the timely and proactive QoS management, and raise service guarantee capability and OAM efficiency.

Automatic Service Recovery

The function of automatic service recovery enables automatic protection and recovery at the service tunnel level. Based on the precise awareness of the awareness engine, the control engine executes recovery actions on a variety of tunnels. According to the information reported by the device, the control engine triggers the recovery module to intelligently calculate the routes and select a new route for the faulty tunnel. Even if ZENIC ONE is abnormal and unable to restore services, the device can automatically calculate the escape path based on the tunnel features and realize automatic service recovery. Athena 2.0 has powerful restoration to greatly enhance service reliability and satisfy SLA needs of high-value services.

Intelligent Fault Diagnosis

The function of intelligent fault diagnosis locates network faults on its own to significantly improve OAM efficiency. It comprises two parts. The first one is to form and update the network fault database. The BigData platform is responsible for data pre-processing of relevant fault data generated by the network, which involves data extraction, cleaning, and aggregation. On this basis, the AI platform executes the fault associated learning algorithm to create a series of related rules and update the results to the network knowledge base. In the second part, when the fault diagnosis is triggered, the system first identifies the root cause alarm based on the knowledge base rules, continues to locate the root cause of the fault based on the knowledge base rules, monitoring data, logs and other data, and offers the solutions. The intelligent fault diagnosis function records the effect of each execution and perfects

the knowledge base to continually improve the efficiency and accuracy of fault diagnosis.

Intelligent Prediction Optimization

The function of traffic prediction analyzes and predicts the traffic of different regions and objects and identifies network bottlenecks as early as possible, so as to optimize or expand the network in time and ensure the long-term quality of network services. Traffic prediction contains two parts. The first one is to select the best prediction algorithm. The BigData platform pre-processes massive traffic data generated by the network, including feature extraction, classification and collection, to form data samples. The AI platform calls in multiple algorithms to predict the data samples and select the algorithm with the best predictive effect. In the second part, when the traffic prediction is triggered, the optimal algorithm is applied to the traffic data to be predicted to form a graphical prediction result and give a warning to the traffic that exceeds expectations. Similar to diagnosis, the traffic prediction function records the effect of each execution and continually optimizes the relevant algorithms through machine learning to further increase the efficiency and accuracy of traffic prediction.

Conclusion

Network intelligence has arrived as expected with 5G. Athena V2.0, ZTE's intelligent network solution, has been commercially used or trialed in networks of world-renowned operators such as China Mobile, China Unicom, China Telecom, Belarus A1, and Columbia TEF, and continues to play a role in improving user efficiency and experience. To actively adapt to the trend of the times, ZTE will work closely with global operators and partners to promote the development of intelligence and speed up the arrival of autonomous networks. **ZTE TECHNOLOGIES**



ZTE Helps China Unicom Shenzhen Verify the World's First 5G SA E2E Slice



Zhou Wenduan

Planning Director of ZTE Transport Products

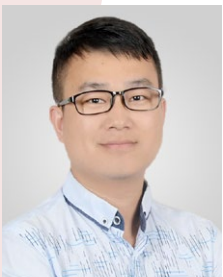

Guo Qianlin

Planning Supervisor of ZTE Transport Products

In the first half of 2020, the wave of new infrastructure has fast-tracked 5G network deployment in China. In particular, the deployment of 5G in vertical industries accelerates the verification of 5G transport slicing applications. On July 16, ZTE, together with China Unicom Shenzhen, verified the world's first app-level 5G SA end-to-end (E2E) network slicing pilot trial in Guangdong, furthering 5G network commercialization. The test focuses on FlexE-based 5G transport network slicing, and demonstrates the strength of ZTE in 5G transport networks.

China Unicom Shenzhen and ZTE have a profound accumulation with respect to technical research and service applications of 5G SA end-to-end slicing, and in-depth cooperation on slice commercialization in the fields of industry, culture and entertainment. In the pilot, a 5G SA end-to-end network spanning the wireless, transport and core

networks was deployed with a slicing operation platform, 5G terminals and multiple apps, and the FlexE-based 5G transport network slicing solution perfectly supports the requirements of multi-scenario application.

Technical Solutions

The ZTE transport network in the pilot uses a range of industry-leading technical solutions, and verifies the efficiency, flexibility, convenience and intelligence of the transport network slicing technology and the management & control integrated system (ZENIC ONE) from multiple angles. The solutions cover transport slicing technology Slicing Channel (FlexE hard slicing and SR+EVPN+H-QoS soft slicing), flexible slice deployment, slice-aware priority scheduling, flow-based measurement iFlow, visible O&M and full lifecycle management.

Slicing Design

Taking into an app's service characteristics and demands into consideration, the ZTE transport network deploys three types of FlexE hard slices based on Slicing Channel: ordinary slice, game acceleration slice and location selection slice to build an exclusive 5G network channel for the app so as to guarantee user and service experience. Hard slices are divided into multiple soft slices through the SR+EVPN+H-QoS soft slicing technology to seamlessly connect with the app's user level system, enabling differentiated segmentation and more complete and sustainable operation services. ZTE and China Unicom have accomplished the intelligent deployment of the whole process of the transport slicing network from design, orchestration, activation to monitoring.

Network Deployment

For the pilot, ZTE has provided its new generation flagship product ZXCTN 9000-EA series for the core/aggregation layers, which supports 2 Tbps/slot and 4×400GE high-density interfaces, and its new generation large-capacity product ZXCTN 6180H for the access layer, which allows 25G/50G/100G flexible bandwidth networking, FlexE intra-board and cross-board aggregation, and ultra-large bandwidth expansion during the entire 5G lifecycle. Based on ZTE's in-house 3-in-1 chipset, the access layer product has a power consumption of 300+ W in full configuration, and the core/aggregation layer product has less than 0.5 W per gigabit, significantly cutting OPEX.

Slicing Service Deployment

ZTE's management and control integrated system (ZENIC ONE) first automates slice customization. With the perfect integration of FlexE hard slicing and SR+EVPN+H-QoS soft slicing, it supports one-click automatic slice deployment and provisions services in minutes,

realizing fast, efficient deployment of customized manageable network slices. Benefiting from the Slicing Channel technology, the latency of the access-layer device at a single node is less than 5 μ s, and that of the core/aggregation layer device at a single node is less than 20 μ s, which helps ensure zero packet loss and microsecond-level jitter for exclusive services.

Slicing O&M

ZTE has innovatively introduced slice-aware priority scheduling and iFlow detection technologies to help the management and control system monitor the network status in real time, realize the industry's fastest millisecond-level flow detection, comprehensively monitor both the control plane and the forwarding plane, and enable fast, accurate fault location and service self-recovery in seconds. The ZENIC ONE system visualizes network O&M, and, based on AI and big data analysis, dynamically tunes the traffic to improve resource utilization by more than 20%. The system makes slice changes, slice resource allocation, and network troubleshooting more flexible, intelligent to raise the O&M efficiency by more than 50%. A collection of leading technologies work together to ensure online changes of end-user subscription information, dynamic network optimization, and exclusive service experience for users of different levels, applications, and locations.

Summary

The success of this pilot deepens the cooperation between ZTE and China Unicom Shenzhen in the pan-entertainment field, and offers a reference for providing end-to-end slice networks for vertical industry applications. Looking into the future, they will continue to explore innovative service models for 5G+ vertical industry applications, jointly build a new 5G ecosystem, and provide consumers with better products and services. **ZTE TECHNOLOGIES**



China Telecom Partners with ZTE to Build a New Metropolitan Area Network

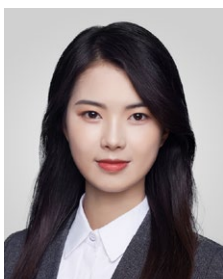

Liu Bingnan

Planning Director of ZTE
IPN Products

In the new 5G era, the existing networks face such new requirements as bandwidth upgrade, service expansion, convenience and flexibility. To ensure the rapid and sustainable development of telecommunications services, operators urgently need to make breakthroughs in network transport, service models, service provisioning, and O&M. With the increasingly urgent requirements for cloud-network synergy and the launch of the "three gigabit" services, China Telecom has been focusing on how to guarantee a consistent user experience across fixed and mobile networks and reduce network construction costs while meeting the requirements for high bandwidth, low latency, and differentiated transport services.

New Requirements: Exploring Future Network Development

With the deepening of enterprise informatization and the continuous development of mobile

Internet and cloud services, various new services and applications have emerged. There is a continuous increase of fixed broadband traffic and a rapid growth of mobile services. The robust growth of 4K/8K video, cloud AR/VR and the distinctive rise of online education put large bandwidth requirements on mobile and fixed transport networks. Autonomous driving and telemedicine require low latency. The rapid development of 2B services require end-to-end on-demand network resource allocation. Intelligentization, openness, and service-based capabilities have become core demands of a new network. The future network needs a re-architecture centered on cloud-network synergy.

In March 2020, China Telecom started the research on the new metropolitan area network (MAN) solution, with an aim to unify the IP MAN and STN network architecture to build fixed and mobile convergence (FMC) networks, improve network efficiency, and

reduce network construction costs. In April 2020, China Telecom deployed pilots in five provinces, including the MANs of Chengdu, Shenzhen, Wuxi, Shanghai, Huzhou, and Hangzhou, to verify the feasibility of the new MAN solution.

New Architecture: FMC for Flexible and Efficient Transport

Adopting a new spine-leaf architecture for networking, China Telecom's new MAN is constructed with point of delivery (POD) as a unit, and supports FMC unified transport. The network is modular and able to expand horizontally like "lego blocks". The service control layer has centralized control and provides resource pooling, breaking the isolation between the hardware resources and improving the efficiency of broadband user access and resource utilization. The network cooperates with multiple levels of cloud resource pools with the NEs deployed close to the user to improve response speed and reliability.

The architecture of the new MAN pilot is shown in Fig. 1, which consists of the access layer (STN-A, OLT), the aggregation layer (A-Leaf) and the metro backbone layer (Spine, B-Leaf, etc.).

Relying on the 163 and CN2 backbone networks, the new MAN architecture can adapt to traffic localization

requirements, support multi-service integrated transport, meet the requirements of large bandwidth, low latency, end-to-end slicing, security and reliability, and base station and home broadband transport. It can also accommodate cloud-based distributed deployments of 5G core networks, MEC and service platforms while meeting transport requirements of government & enterprise private lines/cloud-based private lines. By reconstructing the architecture and transport modes, China Telecom has created a new MAN with flexible service deployment, efficient traffic forwarding, and on-demand NE scheduling.

New Operation: New-Generation Cloud-Network Operation System

China Telecom's new MAN employs the new-generation cloud-network operation support system, which could realize the orchestration and coordination of the new MAN. Using this support system, the network can achieve the goals of cloud-network integration, the integrated transport and automatic provisioning of 5G, major customers, home broadband and other services, flexible adjustment as well as online control.

As the brain of the entire new MAN, the operation support system is able to control

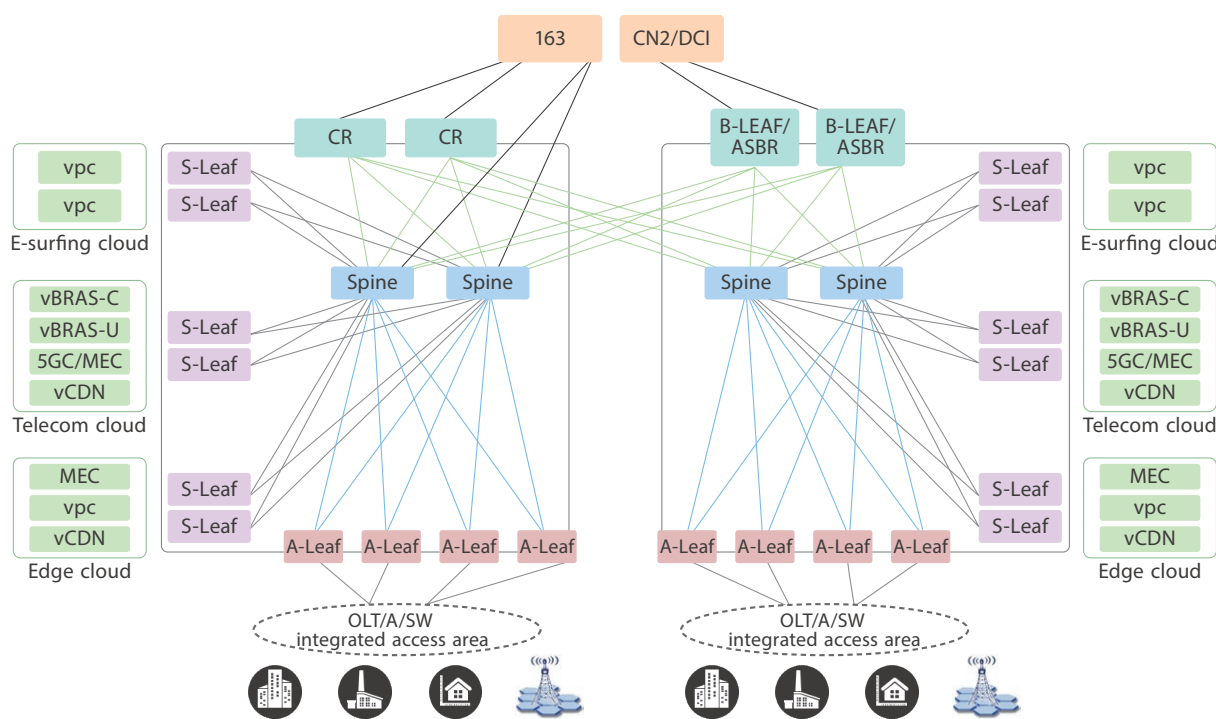

◀ Fig. 1. Architecture of the new MAN pilot.

the MAN fabric NEs such as Spine, Leaf, B and vBRAS-U in a centralized way. With it, the network can perform the configuration tasks for necessary services, intelligent O&M and automatically deliver the configurations.

The intelligent management & control system is the key to ensuring efficient, stable, and reliable network operations. Take the intelligent configuration detection as an example. The configuration detection efficiency can be improved by 90% with the risk identification rate reaching 85%, and the manpower required is shortened from 90 persons to 7 persons per day. This greatly improves the operation efficiency and reduces the network faults. ZTE has deployed its controllers in pilot sites in Chengdu and Shanghai, which work with the O&M support system of China Telecom for intelligent and automatic management of networks and equipment.

New Technology: Simplified Deployment and On-Demand Provisioning of Services

China Telecom's new MAN adopts the new EVPN over SRv6 technology to realize unified fixed and mobile service transport, cloud-network synergy, and convenient end-to-end service provisioning. The FlexE slicing technology is used to build end-to-end rigid pipes to provide differentiated transport services.

The EVPN technology introduces a new network model for Ethernet service delivery. With EVPN, operators can simplify their networks, improve efficiency, and meet evolving requirements for high bandwidth, sophisticated QoS and SLA guarantees. It has become the best model for operators to select for their networks.

SRv6 is a basic technology for future networks and is developing at a fast pace. ZTE SRv6 supports 10 layers of labels and can provide powerful planning capability for paths and services. With the support from the network and service orchestrator, SRv6 can implement the cloud-network path connection and service definition. It is the technology of choice for cloud-network synergy and end-to-end service definition, and provides a new means for fast VPN service deployment.

The FlexE technology can decouple service rates from physical channel rates. It is used to establish

end-to-end FlexE tunnels to isolate multiple service flows. The intermediate nodes do not need to parse service packets, and the one-hop transmission improves service transmission efficiency and physical isolation.

ZTE's related IP products with a complete SRv6/EVPN/FlexE function set have been actively deployed and verified in the existing network. At the forefront of standardization and implementation, ZTE is pushing forward the development of new technologies and protocols in the IP field.

Summary

Planned and guided by experts from China Telecom Group and provincial branches, ZTE fully participated in the new MAN pilot project with its front-end marketing and back-end R&D teams. Capitalizing on its deep technological accumulation in the IP field, ZTE has carried out large-scale network deployment and cutover, demonstrating its powerful strength in end-to-end products and end-to-end deployment. The stable operation of ZTE ZXCTN 9000-EA series, ZXR10 M6000-S series and ZXR10 V6000 vBRAS series and the successful application of SRv6/EVPN/FlexE mark a solid step from theoretical research to large-scale deployment of the new MAN. This is an important innovative achievement of China Telecom in re-architecting the network, which paves the way for the large-scale deployment of the new MAN in 2021.

China Telecom is committed to the research and practice of future network transformation under cloud-network synergy. The new MAN embodies simplicity, agility, centralization, openness and security in terms of network design, equipment selection, and technology selection, and meets the requirements for massive connections and high experience from future individual users, governments and enterprises, vertical industries, and IoT services with a new architecture, new protocol, and new operation. ZTE has made sufficient preparations in terms of intelligent solutions, equipment capability provision, and personnel training & reserves. The company is willing to work closely with China Telecom to actively explore the innovation of 5G network architecture, promote the development of new cloud-network services, and build a new engine for cloud-network synergy. **ZTE TECHNOLOGIES**



True Teams up with ZTE to Build a Superior 5G IPRAN Network

T rue is a full license operator in Thailand with more than 3 million fixed-line users and 28 million mobile users. With a 30% market share and an annual growth rate of 30% in the mobile sector, True is Thailand's second largest mobile operator. To give all users a better communication experience, True started 5G exploration early in 2018 by adhering to the strategy of "one step ahead, all steps ahead", and now becomes the leader in Thailand's 5G deployment. In February 2020, True succeeded in obtaining the 5G license and officially announced its 5G commercial deployment.

Upgrade to 5G IPRAN is Inevitable

Transport network is of primary

importance in the 5G era. With the booming of high-definition videos, online shopping, online games, industrial internet and telemedicine services, users have extensive demands for large bandwidth, low latency and massive connections. True's existing network traffic is growing exponentially, and its bandwidth resources have reached the bottleneck. Because True's incumbent IPRAN does not support key 5G features such as SR, EVPN, SDN, slicing and high-precision clock, it cannot meet the precise, differentiated, agile and service-based requirements of a 5G transport network. Moreover, its multi-vendor networking still has the problems of complicated OAM and high operating expense, and the cost for 100G boards of its transport aggregation equipment is also much higher than that



Liao Wang

ZTE BN Solution Manager

of other operators. To address the pain points in the 5G era such as inability to upgrade smoothly, expensive and inefficient engineering service and high OAM costs, True planned to completely upgrade its networks and build a superior 5G IPRAN network.

Customized 5G IPRAN Improves User Experience

To address the opportunities and challenges in the 5G era, True invited public bidding for 5G transport construction, focusing on new 5G technologies, product performance and capacity, and network stability. This bidding attracted the participation of major transport equipment vendors all over the world. In the end, ZTE stood out in the fierce competition with its excellent performance in POC tests, end-to-end product solutions, and good product performance. ZTE has gained full market share of 5G transport network construction in central and western Thailand, with a total of more than 3000 routers, making it one of True's three major transport equipment suppliers.

After in-depth analysis and research, ZTE has developed a customized 5G transport solution that can help True build an ultra-broadband,

intelligent, easy-to-maintain and evolvable 5G IPRAN network (Fig. 1). The solution is composed of 5G access equipment ZXCTN 6000, 5G transport flagship product ZXCTN 9000-E and unified management and control platform ZENIC ONE. Using ZTE's self-developed chips, ZXCTN 6000 supports 10GE, 50GE and 100GE interfaces, and ZXCTN 9000-E supports 1T line cards that can smoothly evolve to 4T per single slot. This significantly improves network capacity and provides a high-speed bandwidth experience. ZENIC ONE can implement mirror fault emulation, traffic prediction and network optimization, helping to build an intelligent IP network. The solution supports Class C high-precision clock synchronization and has multiple protection mechanisms against link failure, node fault and signal degradation. It also supports key 5G technologies such as SR, EVPN and Slice that can greatly simplify network architecture, shorten service deployment period and realize precision network operation.

Superior 5G IPRAN Helps True Lead the Market

The superior 5G IPRAN network jointly built by True and ZTE is intelligent, efficient, simple,

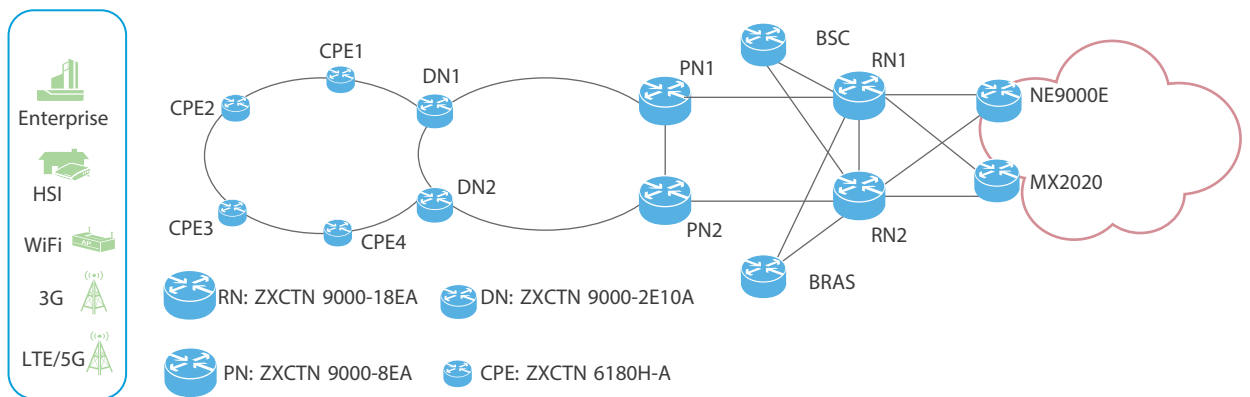

▲ Fig. 1. ZTE's 5G IPRAN solution.

flexible and easy to maintain. It solves the difficulties faced by True in 5G transport network, raises its 5G transport capacity to a higher level, and meets all network requirements in the 5G era.

- **Easy maintainability and high reliability to ensure service performance:** The superior 5G IPRAN network provides AI-based network insight that enables simple, flexible, and visual intelligent management and control, improves the accuracy of potential risk identification and network stability, makes service monitoring more accurate and detailed, and greatly improves OAM efficiency. It also provides end-to-end product solutions that allow for smooth network evolution and easy management to better meet differentiated application needs of vertical industries.
- **Dual mechanisms to cut TCO by 30%:** The superior 5G IPRAN network introduces multiple equipment vendors for competition and thus reduces Capex. Its ZXCTN 9000-E equipment supports all types of line cards, thus greatly reducing network upgrade costs.
- **Deep customization to meet personalized business needs:** The superior 5G IPRAN network provides a low latency of less than 5 μ s and a high-precision clock synchronization of ± 5 ns, which can support ultra-low-latency services such as automatic driving, telemedicine and industrial automation, and expand industrial customers. It also supports explosive mobile traffic growth, Thailand Industry 4.0 and smart factories, satisfying the long-term development needs of 5G services and creating the transport cornerstone for diverse 5G application scenarios.

Work Together to Create a Bright Future for 5G

After successful cooperation between the two parties, the deployment of 5G IPRAN is in full swing in Thailand. True spoke highly



of ZTE's professional competence, service spirit and outstanding performance in 5G IPRAN network construction. "Among three vendors implementing IP/MPLS Transport Network Swap Project, ZTE project management is the best due to ability to deliver key milestones in time specified by True. In addition, ZTE strong support teams, dedicated resources and close coordination have ensured success to the project," said Mr. Jirachai Kunakorn, True's Chief Network Operations Officer.

ZTE will continue to provide excellent and high-quality end-to-end 5G transport solutions to help True build 5G transport networks with ultra-high bandwidth, ultra-low latency and intelligent OAM. This will lay a solid foundation for booming 5G applications and help True keep leading the 5G development in the future. [ZTE TECHNOLOGIES](#)

To enable connectivity and trust everywhere